

Watching Systems in the King Grid

David Auger

Laboratoire PRiSM
Université de Versailles Saint-Quentin-en-Yvelines
Versailles, France

Jari Honkala

Department of Mathematics
Turku University
Turku, Finland

The King Grid

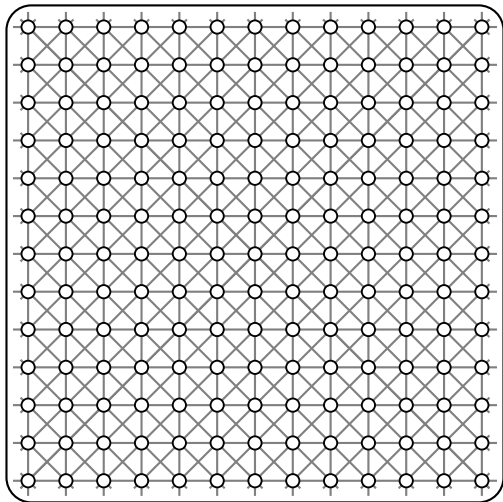

Identifying Code

- \mathcal{C} set of vertices (i.e. $\subset \mathbb{Z}^2$)
- *label* of a vertex $a \in \mathbb{Z}^2$ (w.r.t. \mathcal{C}, r)

$$\begin{aligned}\mathcal{L}_{\mathcal{C}}(a) &:= \{c \in \mathcal{C} : a \in B(c, r)\} \\ &= B(a, r) \cap \mathcal{C}\end{aligned}$$

- *label* of $A \subset \mathbb{Z}^2$

$$\mathcal{L}_{\mathcal{C}}(A) := \cup_{a \in A} \mathcal{L}_{\mathcal{C}}(a)$$

- \mathcal{C} is an $(r, \leq \ell)$ -identifying code if whenever $A, B \subset \mathbb{Z}^2$ with $|A|, |B| \leq \ell$, one has

$$A \neq B \implies \mathcal{L}_{\mathcal{C}}(A) \neq \mathcal{L}_{\mathcal{C}}(B).$$

Watching System

- An r -watcher is a couple $(c, Z(c))$ with $c \in \mathbb{Z}^2$ and $Z \subset B(c, r)$
- \mathcal{W} is a set of r -watchers
- *label* of a vertex $a \in \mathbb{Z}^2$ (w.r.t. \mathcal{W}, r)

$$\mathcal{L}_{\mathcal{W}}(a) := \{w \in \mathcal{W} : a \in Z(c)\}$$

- *label* of $A \subset \mathbb{Z}^2$

$$\mathcal{L}_{\mathcal{W}}(A) := \cup_{a \in A} \mathcal{L}_{\mathcal{W}}(a)$$

- \mathcal{W} is an $(r, \leq \ell)$ -watching system if whenever $A, B \subset \mathbb{Z}^2$ with $|A|, |B| \leq \ell$, one has

$$A \neq B \implies \mathcal{L}_{\mathcal{W}}(A) \neq \mathcal{L}_{\mathcal{W}}(B).$$

Minimum densities for $(r, \leq \ell)$ -id code in the King grid

	$\ell = 1$	$\ell = 2$	$\ell \geq 3$
$r = 1$	$D_{1,1} = \frac{2}{9}$ [CHL02; Coh+01]	$\frac{5}{12} \leq D_{2,1} \leq \frac{3}{7}$ [Pel09] [HL03]	\nexists [HL03]
$r = 2$	$D_{2,1} = \frac{1}{8}$ [Cha+04]	$\frac{31}{120} \leq D_{2,2} \leq \frac{2}{7}$ [HL03] [Pel09]	\nexists [HL03]
$r \geq 3$	$D_{r,1} = \frac{1}{4r}$ [Cha+04]	$D_{r,2} = \frac{1}{4}$ [HL03]	\nexists [HL03]

[CHL02] Charon, Hudry, and Lobstein “Identifying codes with small radius in some infinite regular graphs”

[Coh+01] Cohen, Honkala, Lobstein, and Zémor “On codes identifying vertices in the two-dimensional square lattice with diagonals”

[HL03] Honkala and Laihonen “Codes for identification in the king lattice”

[Pel09] Pelto “New bounds for $(r, \leq 2)$ -identifying codes in the infinite king grid”

Minimum densities for $(r, \leq \ell)$ -id code in the King grid

	1	$\ell = 1$	$\ell = 2$	3	$\ell \geq 3$
$r = 1$		$D_{1,1} = \frac{2}{9}$ [CHL02; Coh+01]	$\frac{5}{12} \leq D_{2,1} \leq \frac{5}{7}$ [Pel09] [HL03]		\nexists [HL03]
$r = 2$		$D_{2,1} = \frac{1}{8}$ [Cha+04]	$\frac{31}{120} \leq D_{2,2} \leq \frac{2}{7}$ [HL03] [Pel09]		\nexists [HL03]
$r \geq 3$	2	$D_{r,1} = \frac{1}{4r}$ [Cha+04]	$D_{r,2} = \frac{1}{4}$ [HL03]		\nexists [HL03]

Comparison with watching systems

1: Minimum density of Id-codes for $r = 1$ and $\ell = 1$

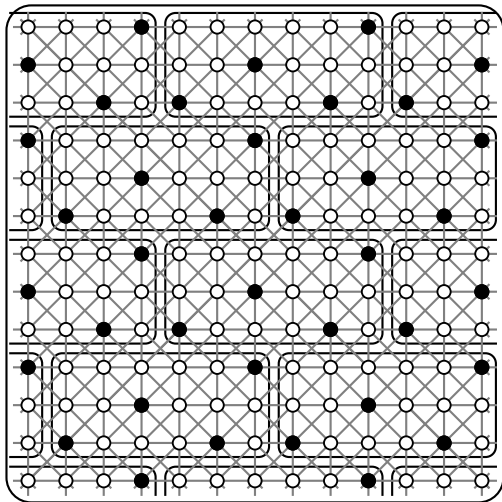

An optimal
(1, ≤ 1)-identifying code
density $\frac{2}{9}$

Proof of optimality
(lower bound $\frac{2}{9}$):

Cohen, Honkala, Lobstein,
Zémor
2001

Construction :

Charon, Hudry, Lobstein
2002

What about watching systems ?

Theorem

The minimal density of a $(1, \leq 1)$ -watching system in the King grid is $\frac{2}{9}$.

idea of proof

- only the lower bound to prove
- double-count (in a finite area) the number of pairs (w, x) where $d(w, x) \leq 1$
- show that if there are local configurations with few watchers, there are more around with lots of watchers
- (shake)
- it works

2: Asymptotic result for $l = 1$ and $r \rightarrow \infty$

	$l = 1$	$l = 2$	$l \geq 3$
$r = 1$	$D_{1,1} = \frac{2}{9}$ [CHL02; Coh+01]	$\frac{5}{12} \leq D_{2,1} \leq \frac{3}{7}$ [Pel09] [HL03]	\nexists [HL03]
$r = 2$	$D_{2,1} = \frac{1}{8}$ [Cha+04]	$\frac{31}{120} \leq D_{2,2} \leq \frac{2}{7}$ [HL03] [Pel09]	\nexists [HL03]
$r \geq 3$	$D_{r,1} = \frac{1}{4r}$ [Cha+04]	$D_{r,2} = \frac{1}{4}$ [HL03]	\nexists [HL03]

2

2: Asymptotic result for $\ell = 1$ and $r \rightarrow \infty$

Theorem

The minimal density w_r of an $(r, \leq 1)$ -watching system in the King grid satisfies

$$w_r \sim_{r \rightarrow +\infty} \frac{\log_2 r}{2r^2} = o\left(\frac{1}{4r}\right)$$

2: Asymptotic result for $\ell = 1$ and $r \rightarrow \infty$

Theorem

The minimal density w_r of an $(r, \leq 1)$ -watching system in the King grid satisfies

$$w_r \sim_{r \rightarrow +\infty} \frac{\log_2 r}{2r^2} = o\left(\frac{1}{4r}\right)$$

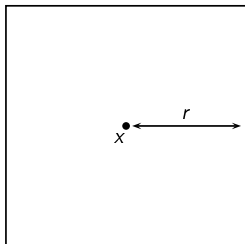

Upper bound:

$\rightarrow (2r + 1)^2$ vertices in $B(x, r)$

$\rightarrow \log_2((2\lfloor \epsilon r \rfloor + 1)^2 + 1)$ in the centre for identification by dichotomy

$$w_r \leq \frac{\lceil \log_2((2r + 1)^2 + 1) \rceil}{(2r + 1)^2} \sim \frac{\log_2 r}{2r^2}$$

2: Asymptotic result for $\ell = 1$ and $r \rightarrow \infty$

Theorem

The minimal density w_r of an $(r, \leq 1)$ -watching system in the King grid satisfies

$$w_r \sim_{r \rightarrow +\infty} \frac{\log_2 r}{2r^2} = o\left(\frac{1}{4r}\right)$$

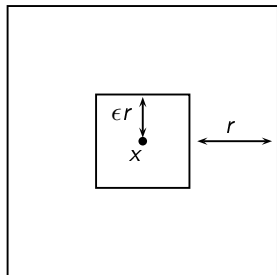

Lower bound:

To identify vertices in $B(x, \epsilon r)$ we need

$$\log_2((2\lceil \epsilon r \rceil + 1)^2 + 1)$$

watchers centred in $B(x, (1 + \epsilon)r)$.

$$w_r \geq \frac{\log_2((2\epsilon r + 1)^2 + 1)}{(2\lceil (1 + \epsilon)r \rceil + 1)^2} \sim \frac{\log_2 r}{2(1 + \epsilon)^2 r^2}$$

3: Watching sets of vertices within distance 1

	$\ell = 1$	$\ell = 2$	3	$\ell \geq 3$
$r = 1$	$D_{1,1} = \frac{2}{9}$ [CHL02; Coh+01]	$\frac{5}{12} \leq D_{2,1} \leq \frac{7}{7}$ [Pel09] [HL03]	\nexists [HL03]	
$r = 2$	$D_{2,1} = \frac{1}{8}$ [Cha+04]	$\frac{31}{120} \leq D_{2,2} \leq \frac{2}{7}$ [HL03] [Pel09]		
$r \geq 3$	$D_{r,1} = \frac{1}{4r}$ [Cha+04]	$D_{r,2} = \frac{1}{4}$ [HL03]		

Relevant question for Watching Systems

Is there a $(1, \leq \ell)$ -WS with density *strictly* less than 1 ?

A construction for $\ell = 4$ and $r = 1$

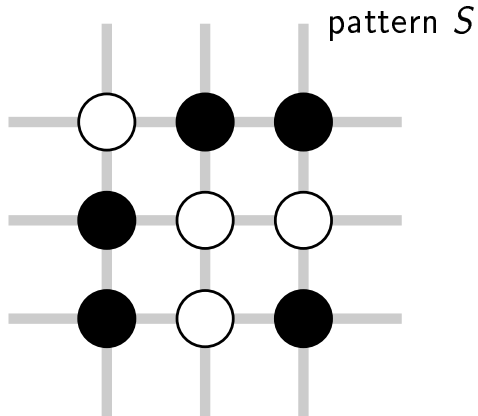

A construction for $\ell = 4$ and $r = 1$

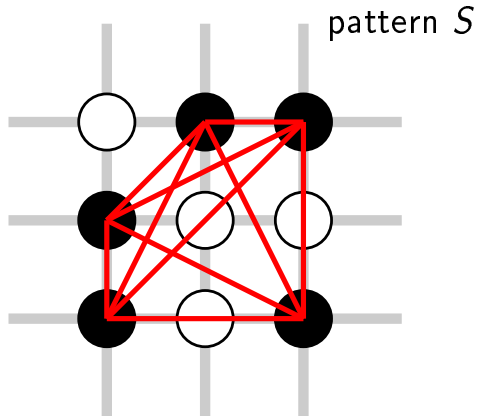

pairwise differences between elements of S are distinct

A construction for $\ell = 4$ and $r = 1$

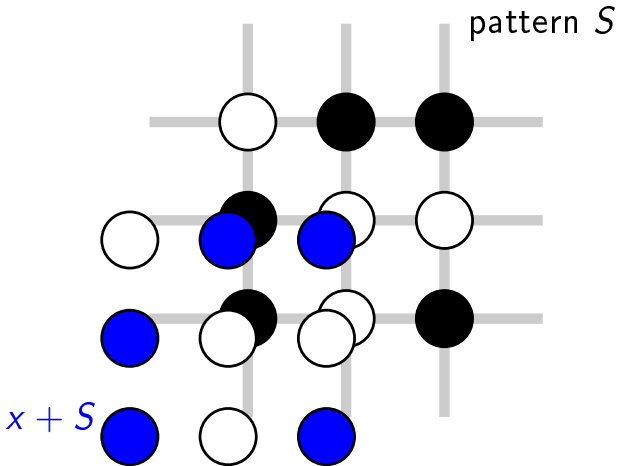

pairwise differences between elements of S are distinct
 \implies translates of S have at most 1 vertex in common

A construction for $\ell = 4$ and $r = 1$

Construction:

- put a watcher on every vertex, with watching zone S (identification with translates of S);
- then remove a few watchers.

A construction for $\ell = 4$ and $r = 1$

Construction:

- put a watcher on every vertex, with watching zone S (identification with translates of S);
- then remove a few watchers.

Idea of proof

- Choose $A \neq B$ sets of at most 4 vertices, show $\mathcal{L}_W(A) \neq \mathcal{L}_W(B)$

A construction for $\ell = 4$ and $r = 1$

Construction:

- put a watcher on every vertex, with watching zone S (identification with translates of S);
- then remove a few watchers.

Idea of proof

- Choose $A \neq B$ sets of at most 4 vertices, show $\mathcal{L}_W(A) \neq \mathcal{L}_W(B)$
- If $a \in A \setminus B$
 - a has label $a - S$, size 5.
 - by S 's property we have $(a - S) \setminus (B - S) \neq \emptyset$
 - so $\mathcal{L}_W(A) \neq \mathcal{L}_W(B)$!

A construction for $\ell = 4$ and $r = 1$

Construction:

- put a watcher on every vertex, with watching zone S (identification with translates of S);
- then remove a few watchers.

Idea of proof

- Choose $A \neq B$ sets of at most 4 vertices, show $\mathcal{L}_{\mathcal{W}}(A) \neq \mathcal{L}_{\mathcal{W}}(B)$
- If $a \in A \setminus B$
 - a has label $a - S$, size 5.
 - by S 's property we have $(a - S) \setminus (B - S) \neq \emptyset$
 - so $\mathcal{L}_{\mathcal{W}}(A) \neq \mathcal{L}_{\mathcal{W}}(B)$!
- In fact $\mathcal{L}_{\mathcal{W}}(A) \Delta \mathcal{L}_{\mathcal{W}}(B)$ has size at least 2 \rightarrow remove a few watchers from \mathcal{W}

A construction for $\ell = 4$ and $r = 1$

Generalization:

Theorem

Let $\ell \geq 2$. Assume that there exists a set S of $\ell + 1$ vertices

$$S = \{s_1, s_2, \dots, s_{\ell+1}\} \subseteq B(0, r)$$

such that all the pairwise differences $s_i - s_j$ for $1 \leq i < j \leq \ell + 1$ are different. Then there is an $(r, \leq \ell)$ watching system with density

$$D = 1 - \frac{1}{(4r + 1)^2} < 1$$

in the King grid.

The case $\ell \geq 6$ and $r = 1$

Theorem

In the King grid every $(1, \leq \ell)$ -watching system with $\ell \geq 6$ has density at least 1.

Lemma

A set X of vertices, not containing x , but intersecting all the zones of the watchers watching x , has size at least ℓ .

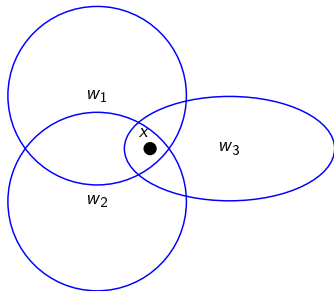

The case $\ell \geq 6$ and $r = 1$

Theorem

In the King grid every $(1, \leq \ell)$ -watching system with $\ell \geq 6$ has density at least 1.

Lemma

A set X of vertices, not containing x , but intersecting all the zones of the watchers watching x , has size at least ℓ .

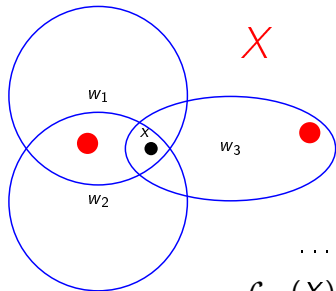

... since we have

$$\mathcal{L}_{\mathcal{W}}(X) = \mathcal{L}_{\mathcal{W}}(X \cup \{x\})$$

The case $\ell \geq 6$ and $r = 1$

Theorem

In the King grid every $(1, \leq \ell)$ -watching system with $\ell \geq 6$ has density at least 1.

(elements of) Proof.

Suppose \mathcal{W} is a $(1, \leq 6)$ -WS.

Every watcher w has weight 1 and confers a weight $\frac{1}{|Z(w)|}$ to all its watched vertices.

→ Show that all vertices have weight 1

The case $\ell \geq 6$ and $r = 1$

Theorem

In the King grid every $(1, \leq \ell)$ -watching system with $\ell \geq 6$ has density at least 1.

(elements of) Proof.

Suppose \mathcal{W} is a $(1, \leq 6)$ -WS.

Every watcher w has weight 1 and confers a weight $\frac{1}{|Z(w)|}$ to all its watched vertices.

→ Show that all vertices have weight 1

If x is watched by only 1 watcher: OK.

The case $\ell \geq 6$ and $r = 1$

Theorem

In the King grid every $(1, \leq \ell)$ -watching system with $\ell \geq 6$ has density at least 1.

(elements of) Proof.

Suppose \mathcal{W} is a $(1, \leq 6)$ -WS.

Every watcher w has weight 1 and confers a weight $\frac{1}{|Z(w)|}$ to all its watched vertices.

→ Show that all vertices have weight 1

If x is watched by only 1 watcher: OK.

If not → at least 6 watchers since

To cover the zones of those watchers watching x with vertices $\neq x$, you need at least 6 vertices

The case $\ell \geq 6$ and $r = 1$

Theorem

In the King grid every $(1, \leq \ell)$ -watching system with $\ell \geq 6$ has density at least 1.

If x is watched by 9 or more watchers

$\longrightarrow x$ has weight at least

$$9 \times \frac{1}{9}$$

The case $\ell \geq 6$ and $r = 1$

Theorem

In the King grid every $(1, \leq \ell)$ -watching system with $\ell \geq 6$ has density at least 1.

If x is watched by 8 watchers: $w_1, w_2, w_3, \dots, w_8$

To cover the zones of those watchers watching x with vertices $\neq x$, you need at least 6 vertices

The case $\ell \geq 6$ and $r = 1$

Theorem

In the King grid every $(1, \leq \ell)$ -watching system with $\ell \geq 6$ has density at least 1.

If x is watched by 8 watchers: $w_1, w_2, w_3, \dots, w_8$

To cover the zones of those watchers watching x with vertices $\neq x$, you need at least 6 vertices

If w_1, w_2, w_3 can be covered with one vertex $\neq x$

we need 5 vertices to cover w_4, w_5, w_6, w_7, w_8

\rightarrow zones pairwise distinct in $B(x, 2)$ (except in x)

weight of x at least

$$\frac{3}{9} + \frac{5}{1 + \frac{24}{5}} > 1$$

The case $\ell \geq 6$ and $r = 1$

Theorem

In the King grid every $(1, \leq \ell)$ -watching system with $\ell \geq 6$ has density at least 1.

If x is watched by 8 watchers

$$w_1, w_2, w_3, \dots, w_8$$

and three of these watchers cannot be covered with 1 vertex $\neq x$

Every vertex of $B(x, 2) - x$ watched by at most 2 of $w_1, w_2 \dots w_8$

weight of x at least

$$\frac{8}{\frac{48}{8} + 1} > 1$$

The case $\ell \geq 6$ and $r = 1$

Theorem

In the King grid every $(1, \leq \ell)$ -watching system with $\ell \geq 6$ has density at least 1.

If x is watched by 7 watchers

at least 5 have pairwise distinct zones – except in x

weight of x at least

$$\frac{2}{9} + \frac{5}{\frac{24}{5} + 1} > 1$$

The case $\ell \geq 6$ and $r = 1$

Theorem

In the King grid every $(1, \leq \ell)$ -watching system with $\ell \geq 6$ has density at least 1.

If x is watched by 6 watchers

all the watchers have pairwise distinct zones except in x

weight of x at least

$$\frac{6}{\frac{24}{6} + 1} > 1$$

(the end)

Thank you for your attention