

# Counting resolving sets in graphs

**Antonio González**

**University of Seville**

**Joint work with D. Garijo and A. Márquez**



# Resolving Sets and Metric Dimension

# Resolving Sets and Metric Dimension

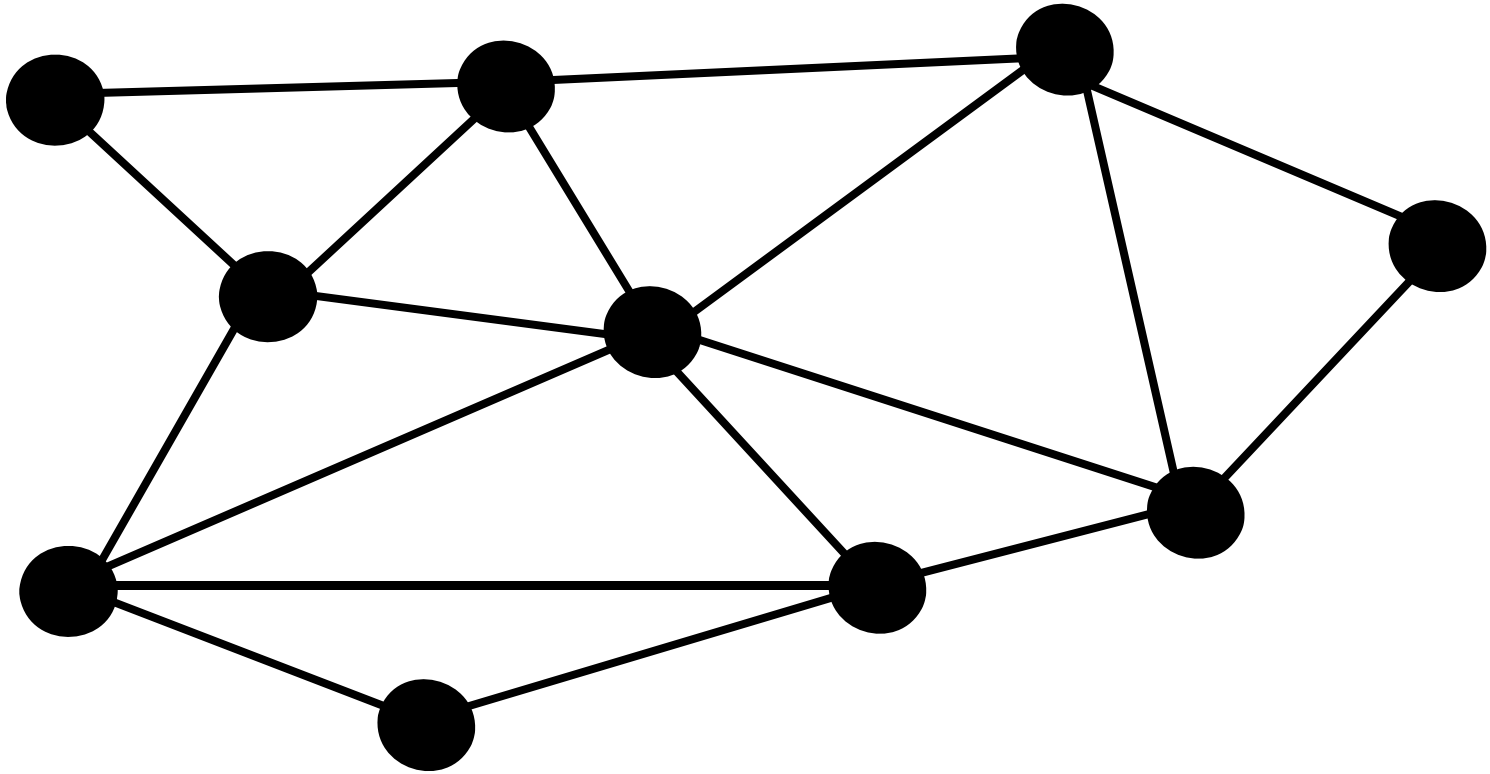

# Resolving Sets and Metric Dimension

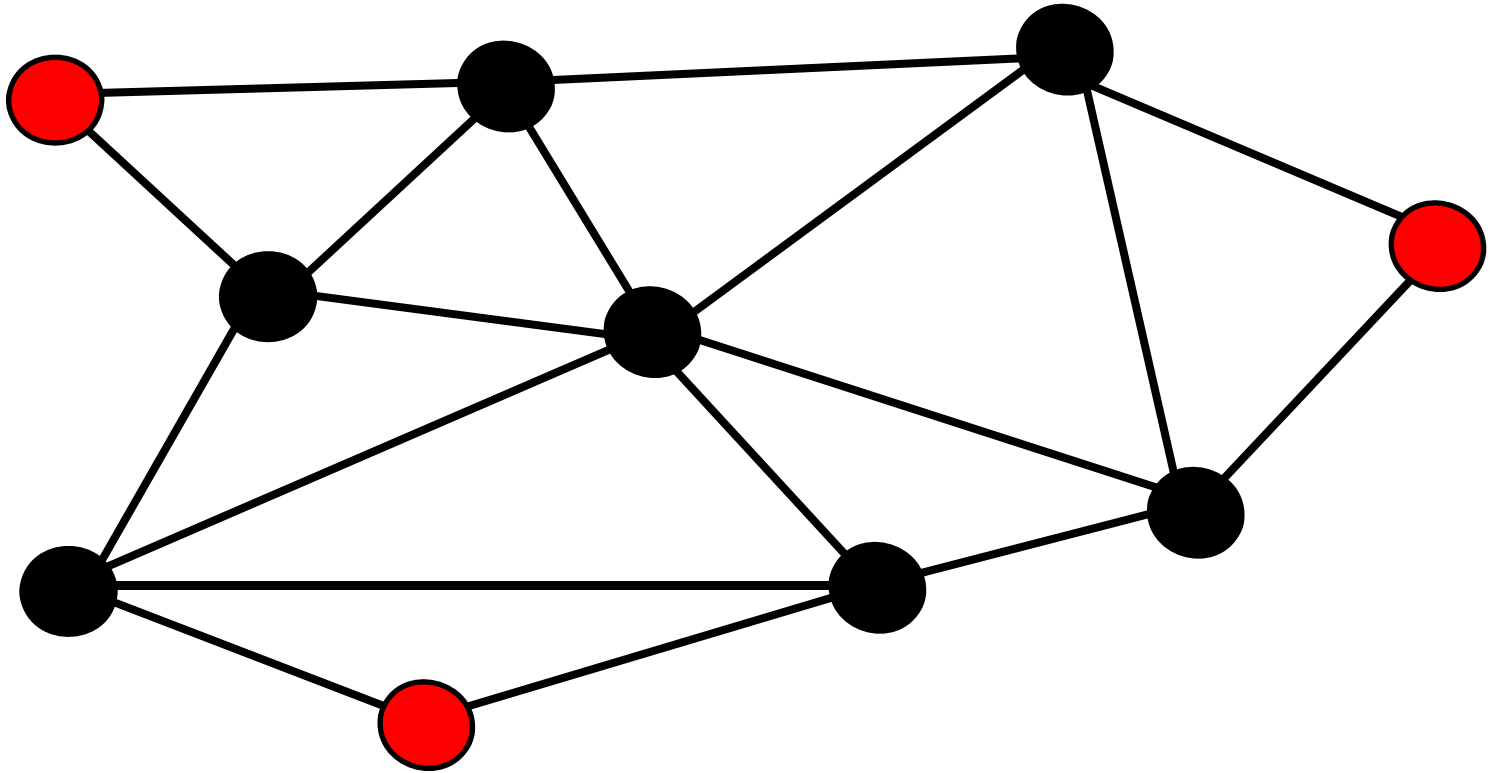

# Resolving Sets and Metric Dimension

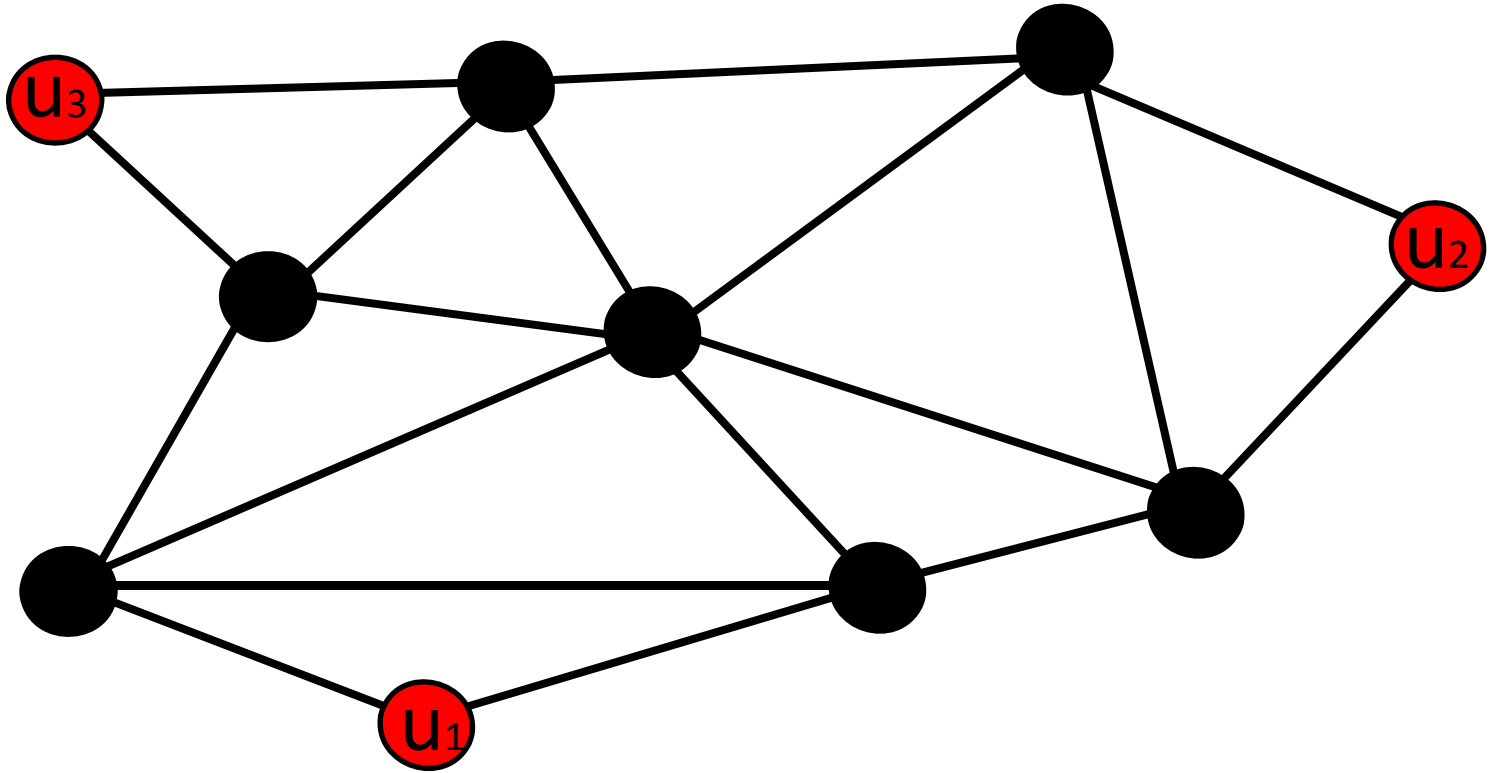

# Resolving Sets and Metric Dimension

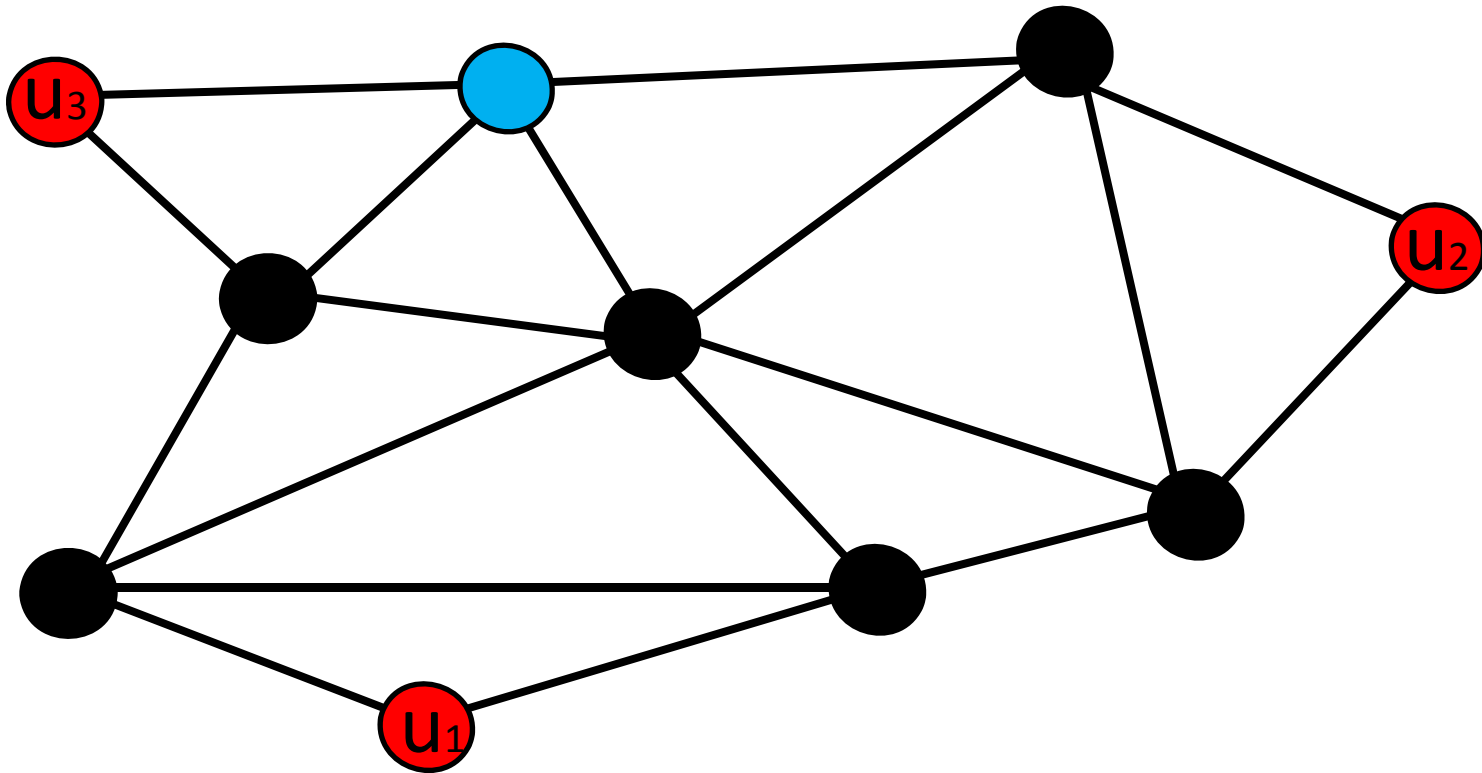

# Resolving Sets and Metric Dimension

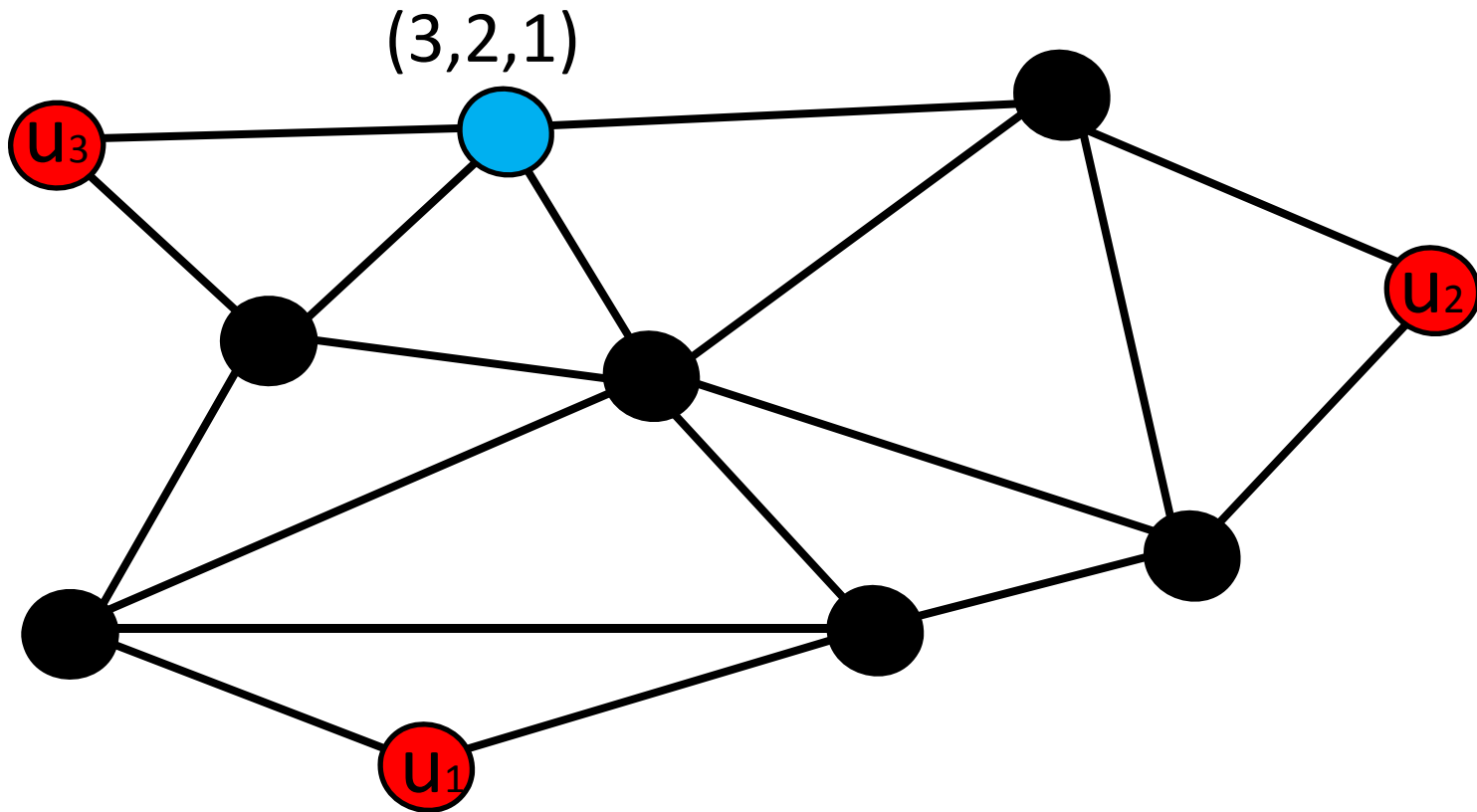



# Resolving Sets and Metric Dimension

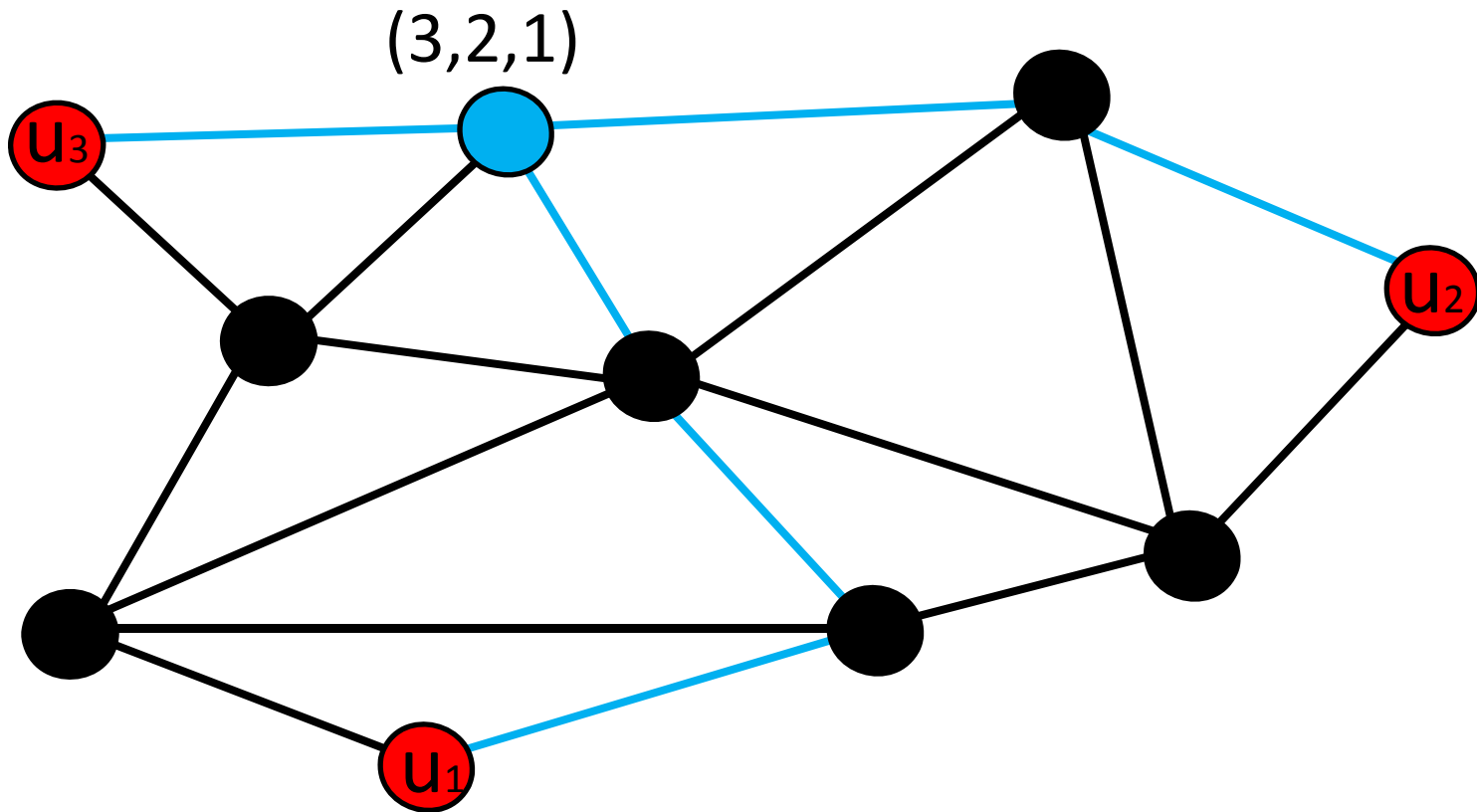

# Resolving Sets and Metric Dimension

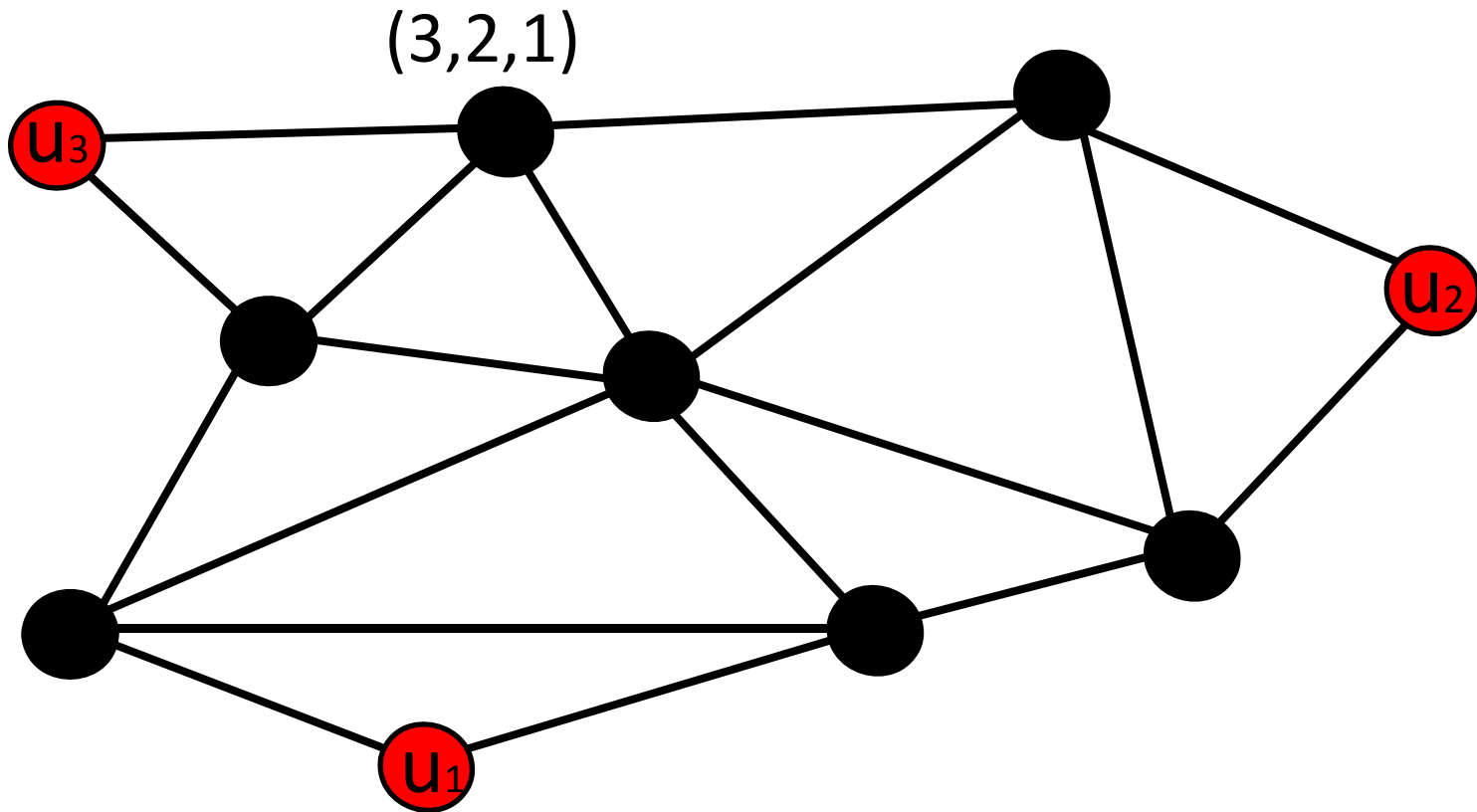

# Resolving Sets and Metric Dimension

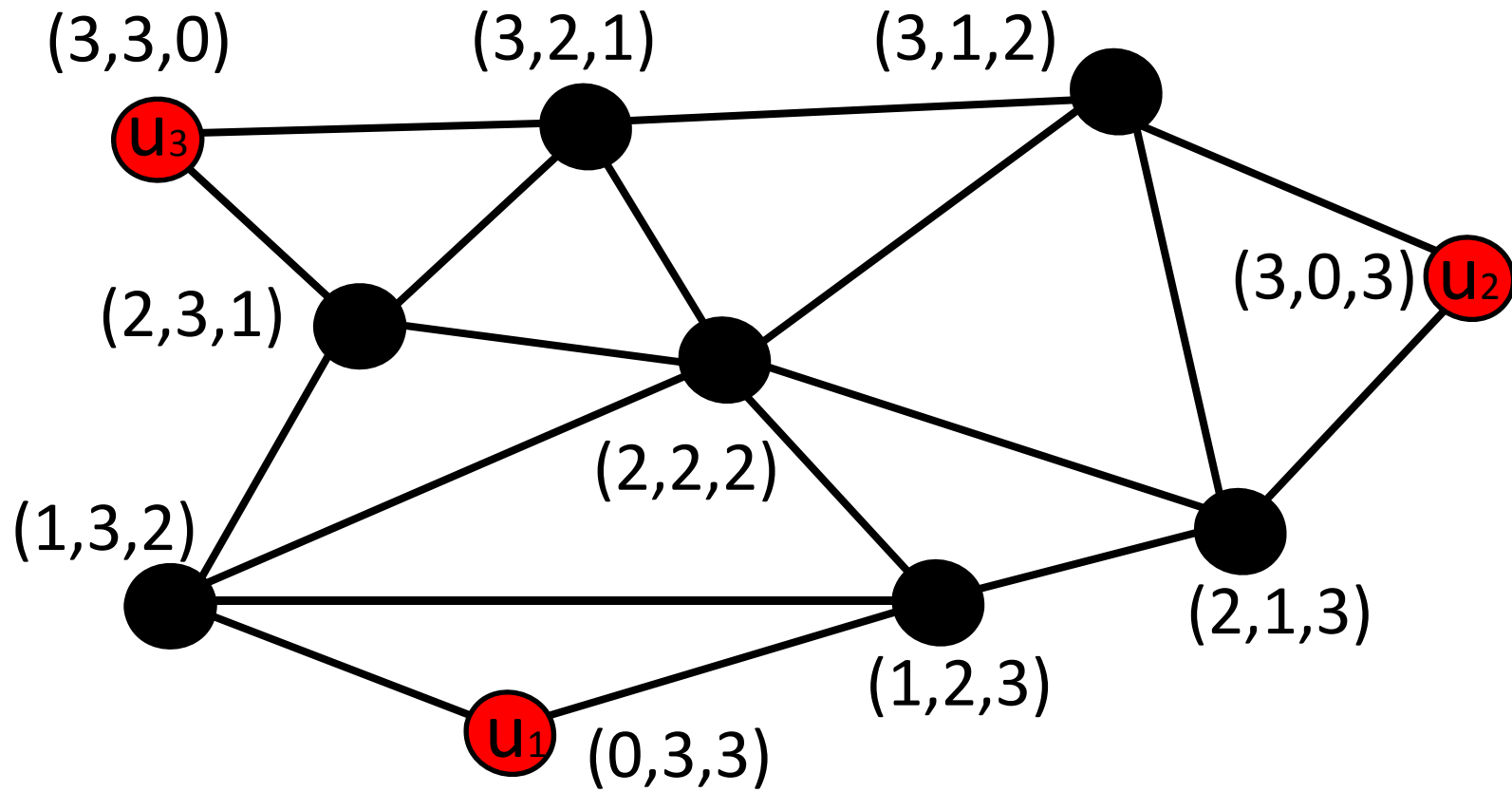

# Resolving Sets and Metric Dimension

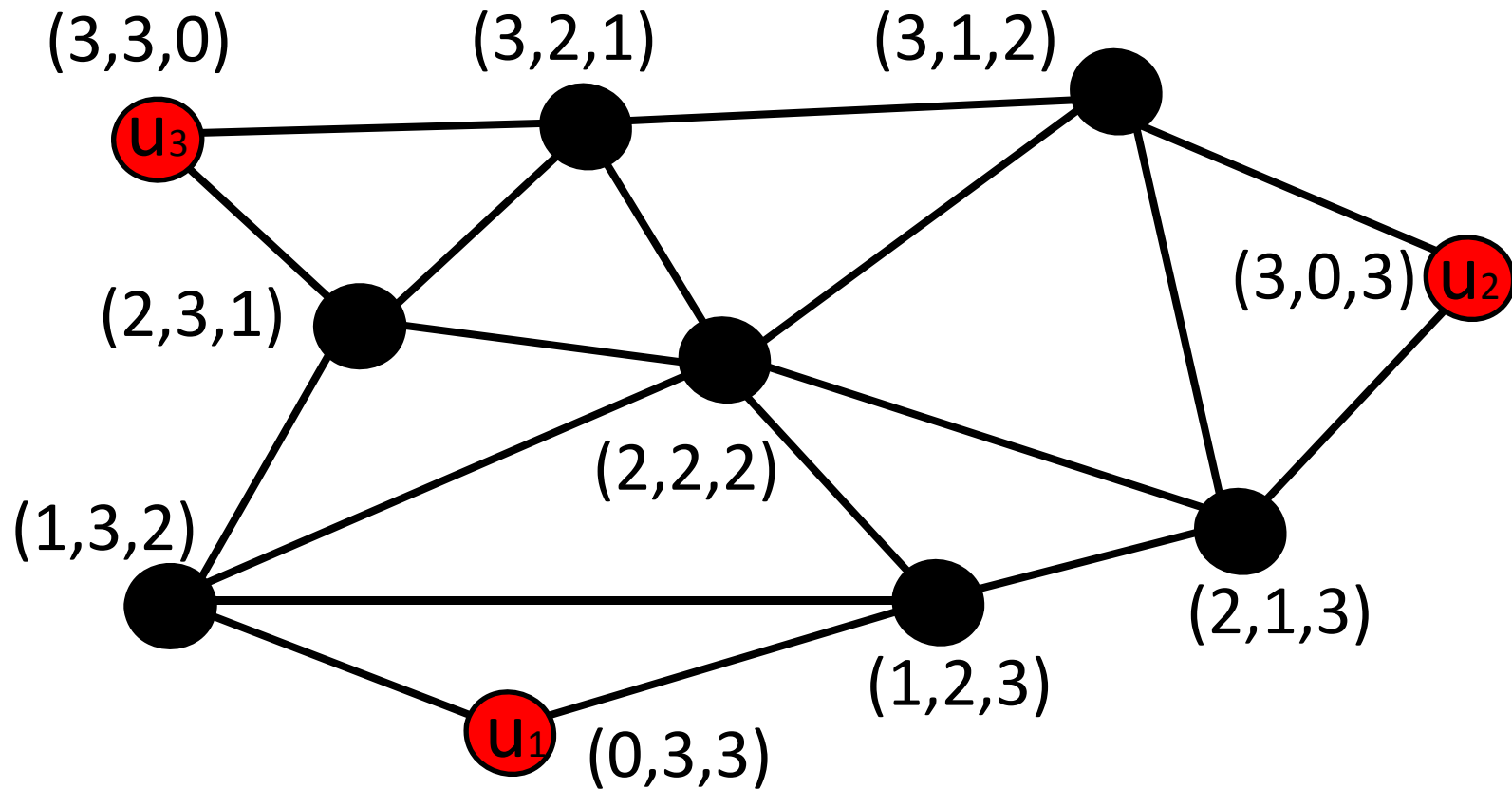

# Resolving Sets and Metric Dimension

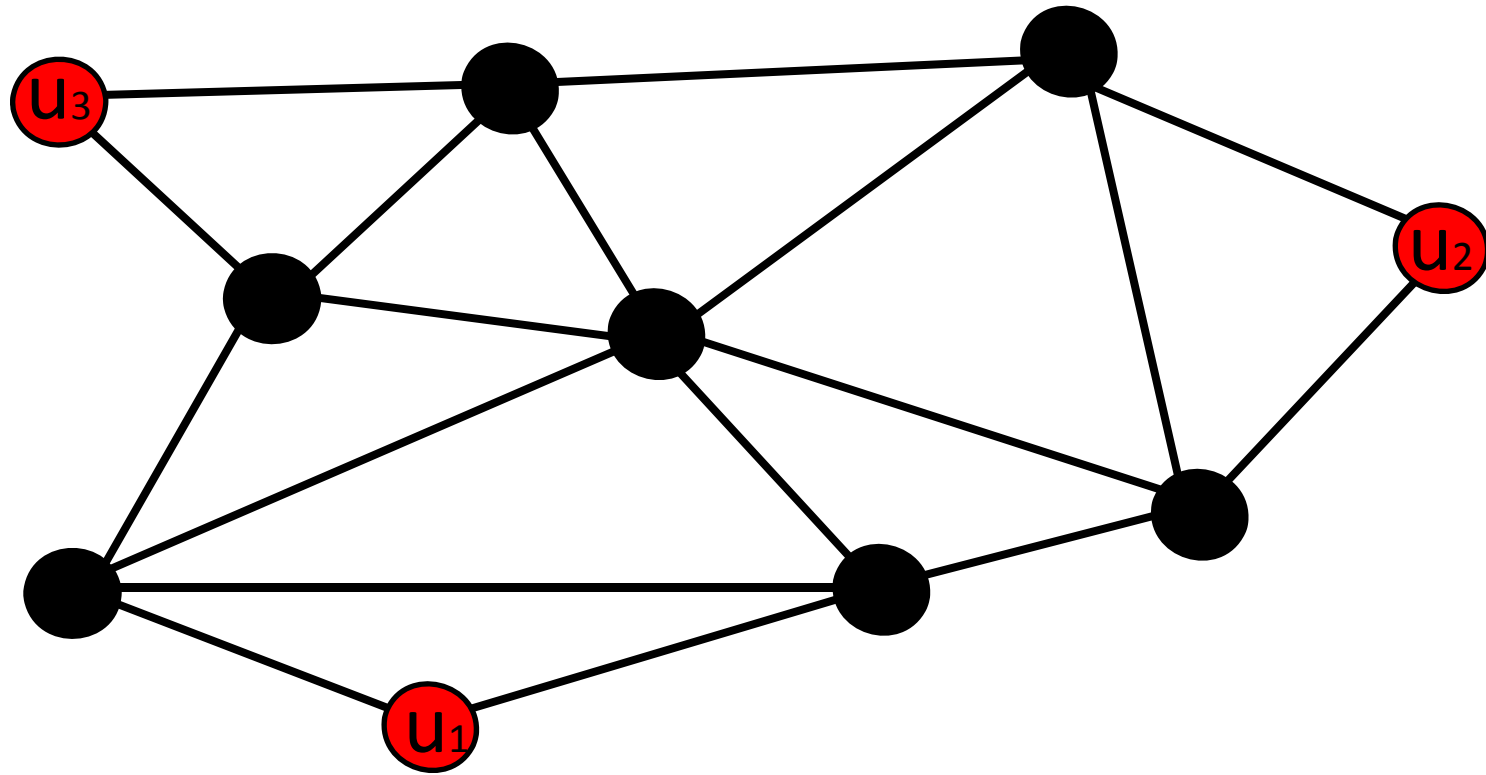

# Resolving Sets and Metric Dimension

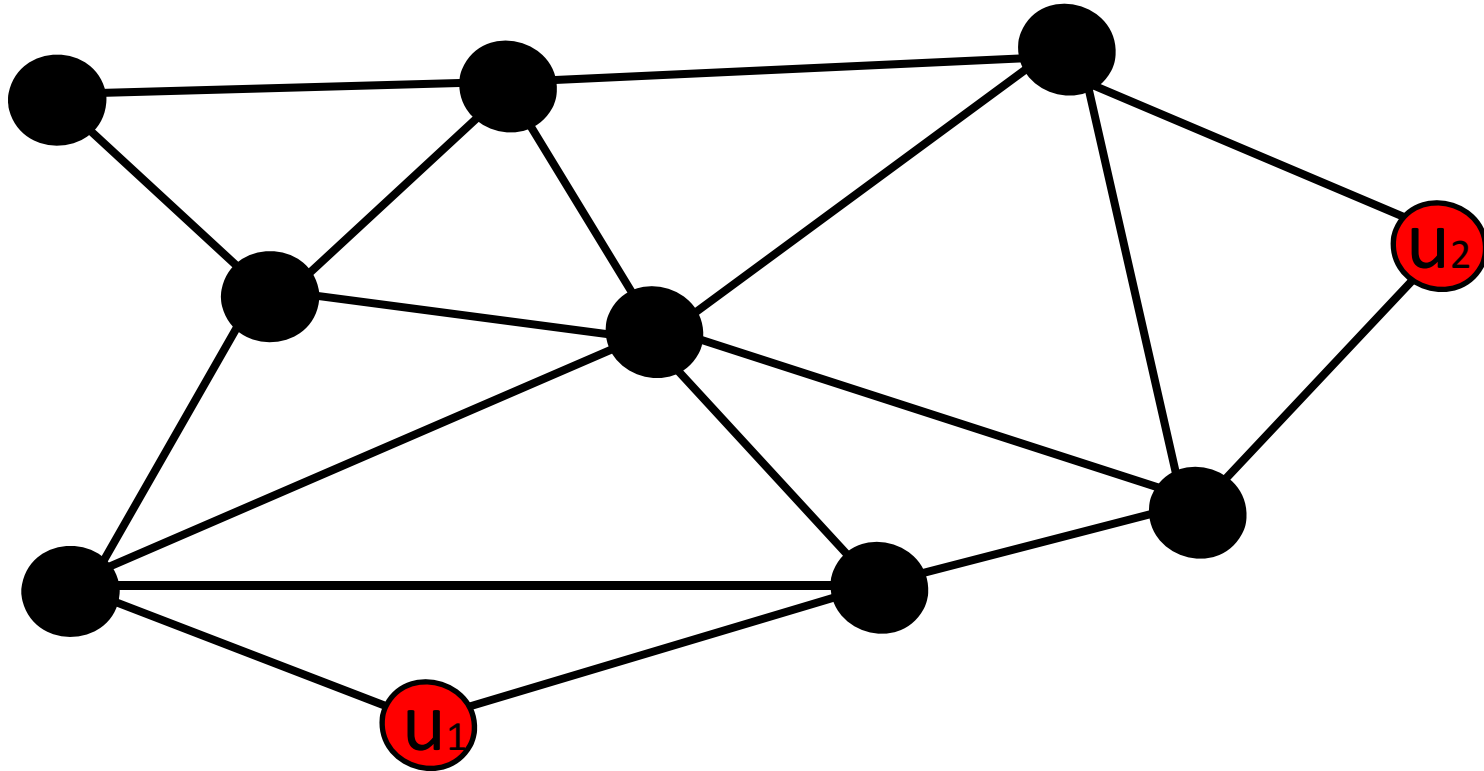

# Resolving Sets and Metric Dimension

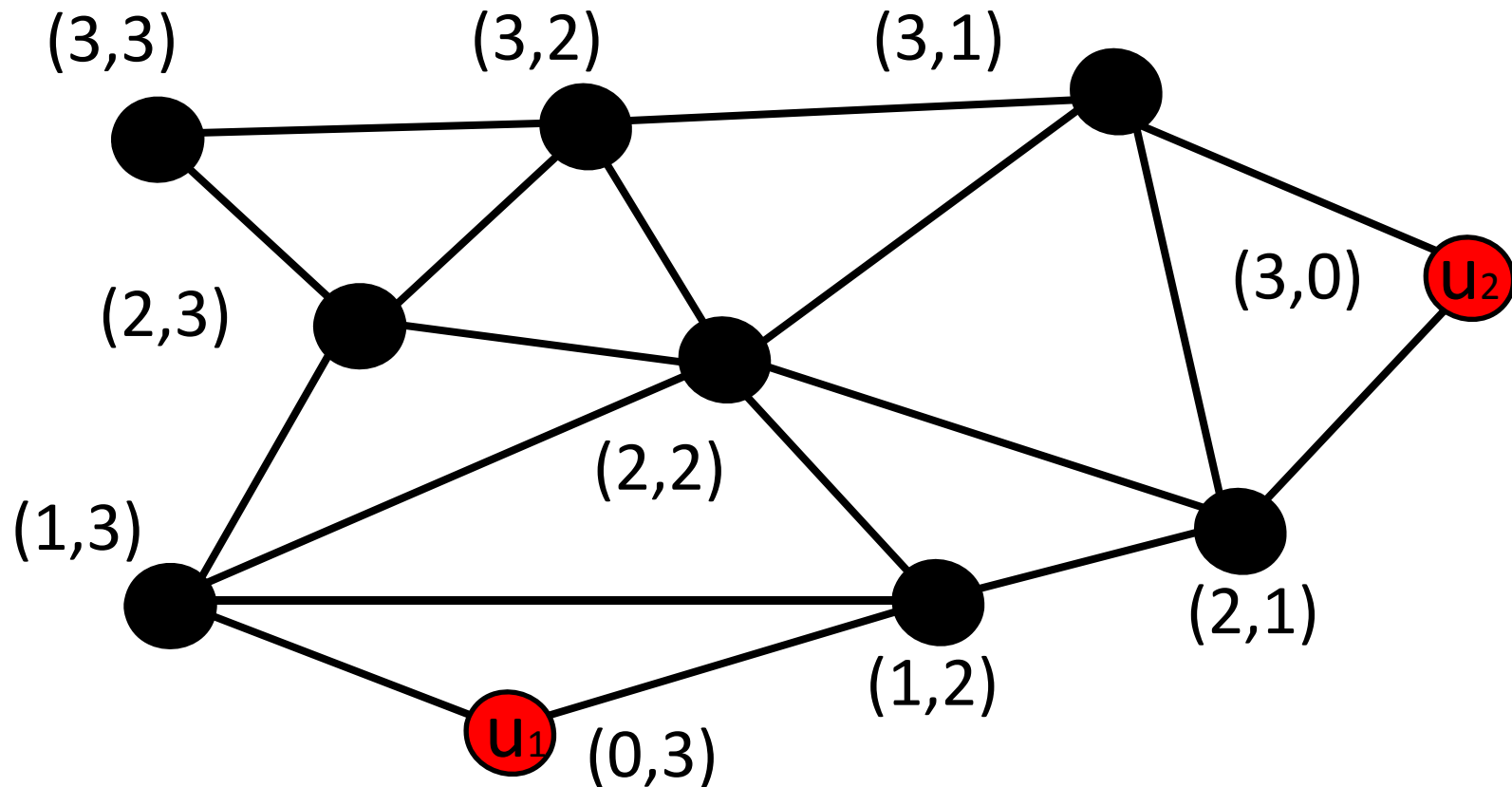

# Resolving Sets and Metric Dimension

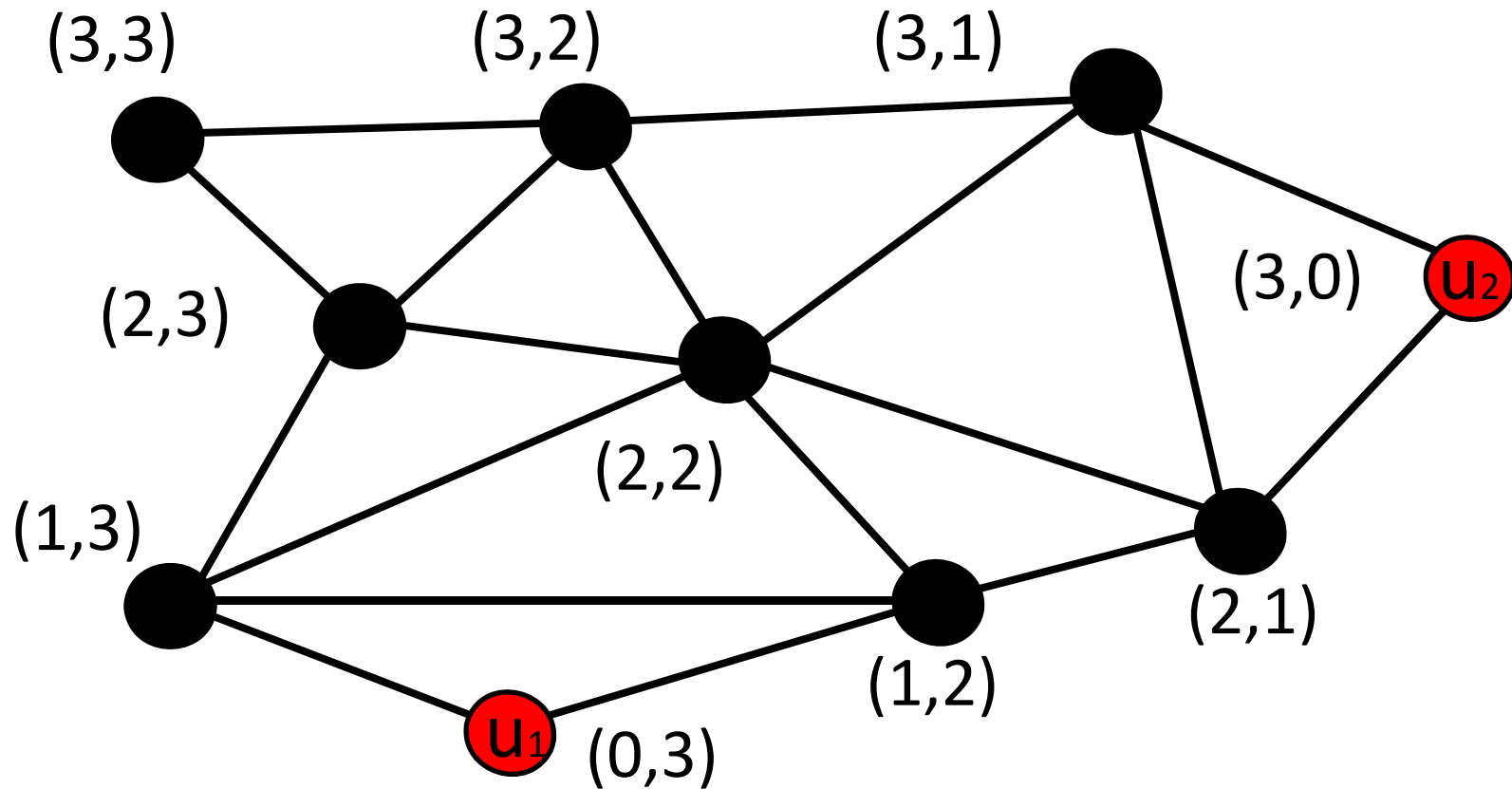



# Resolving Sets and Metric Dimension

$\dim(G) =$  cardinality of a minimum resolving set

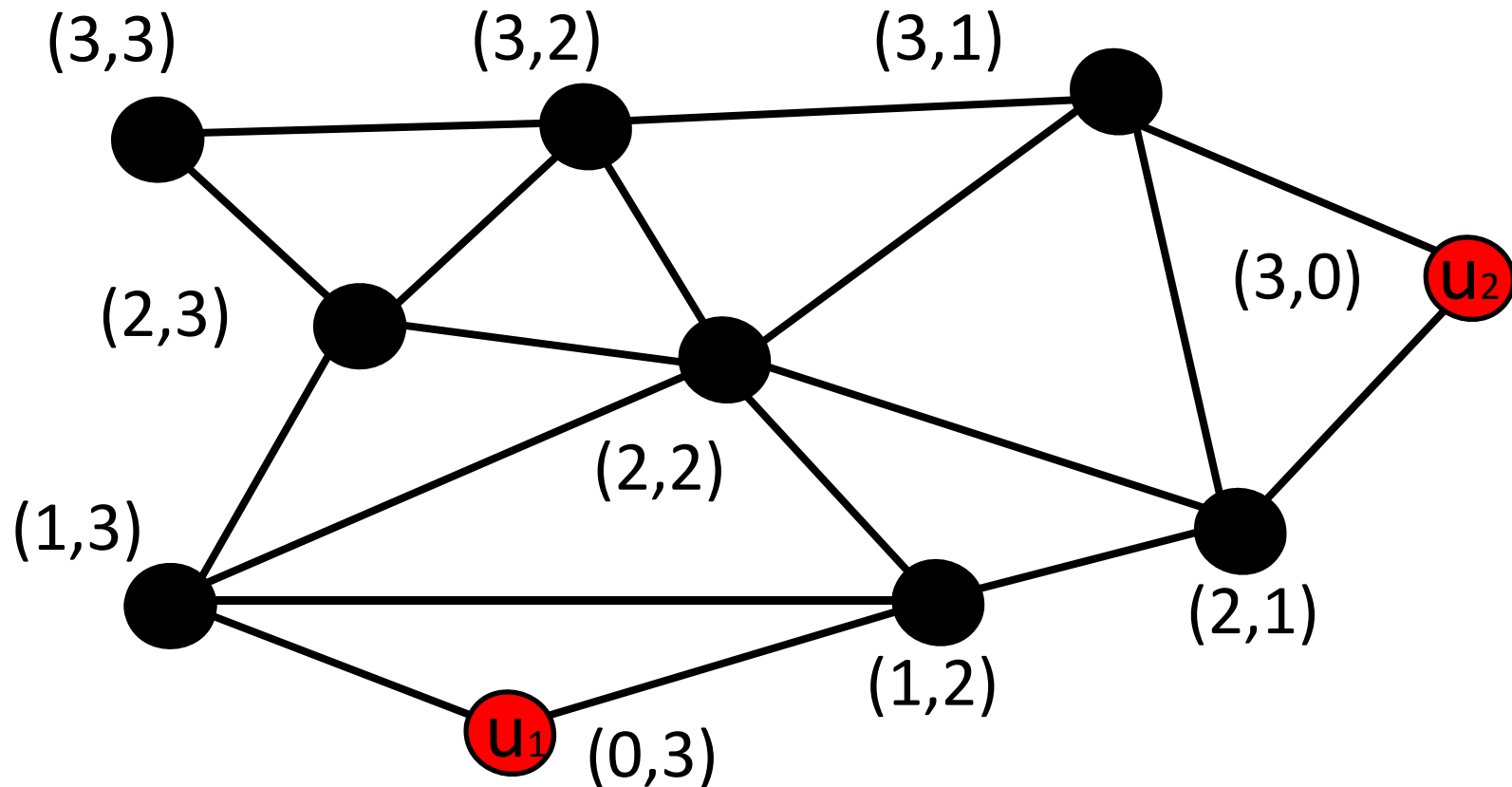

# Resolving Sets and Metric Dimension

$\dim(G) =$  cardinality of a minimum resolving set

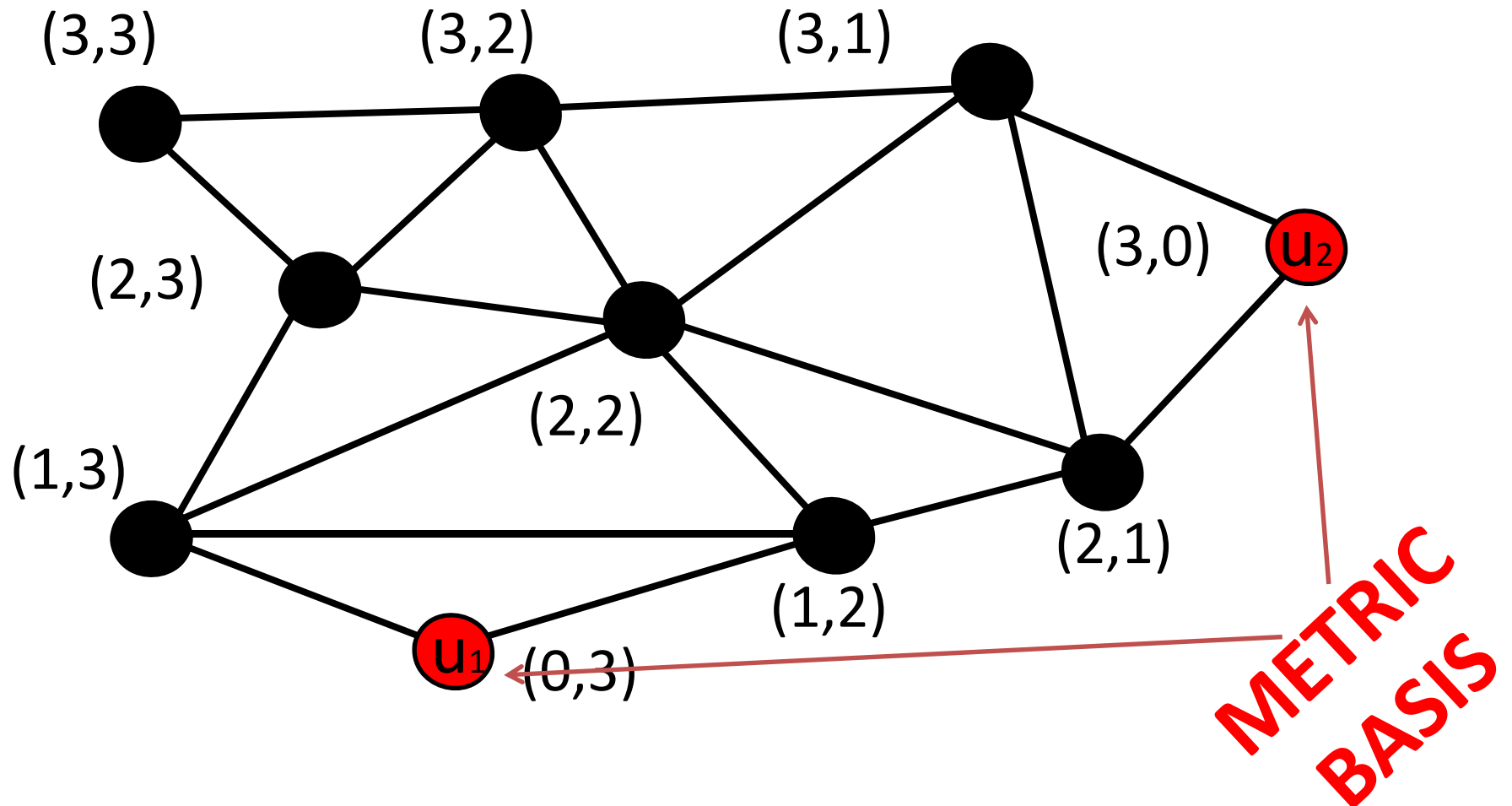

The number of resolving sets of a graph

# The number of resolving sets of a graph

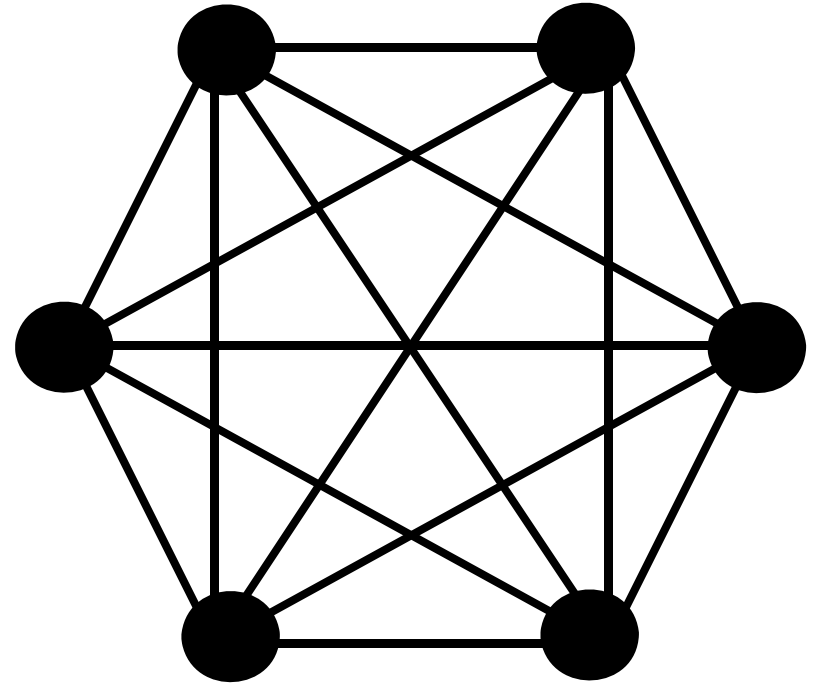
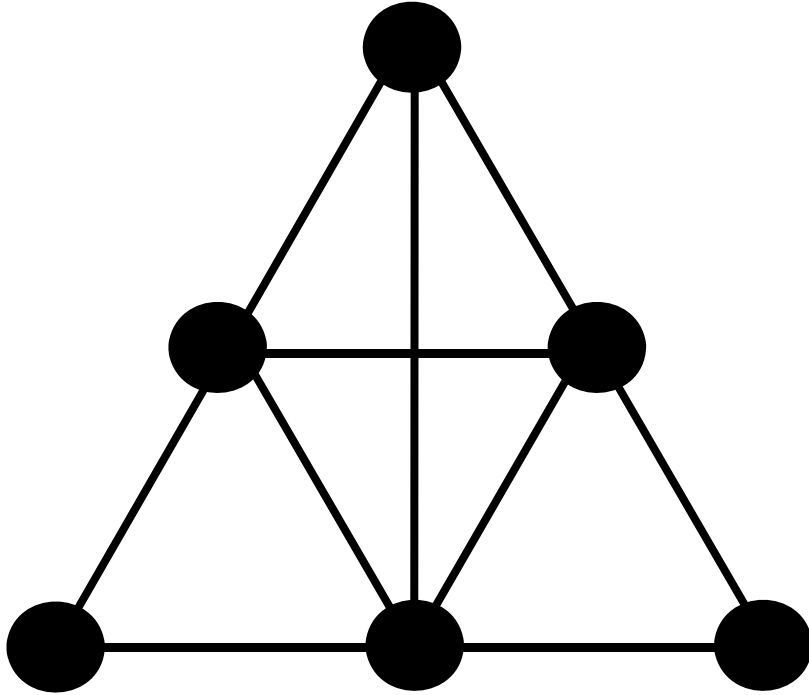

# The number of resolving sets of a graph

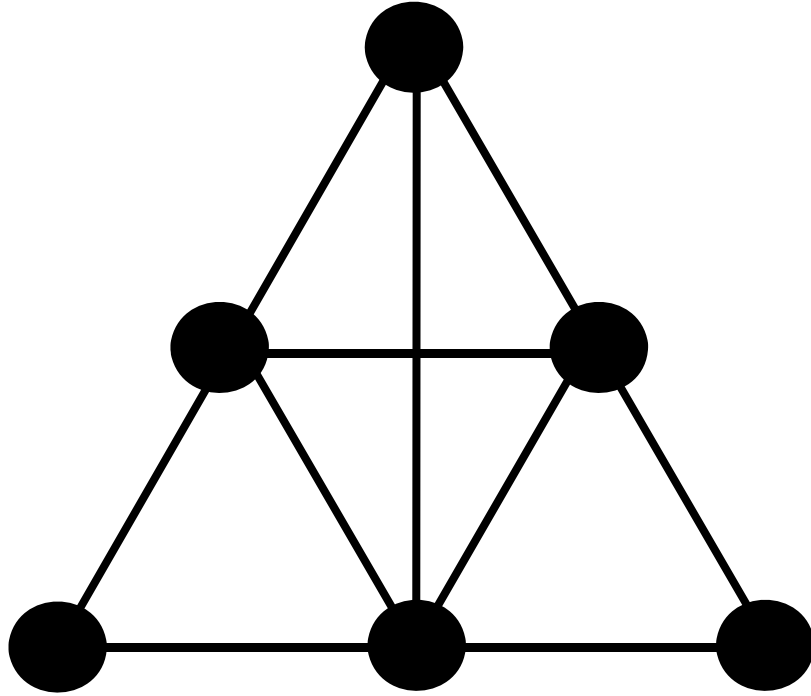

dim=2

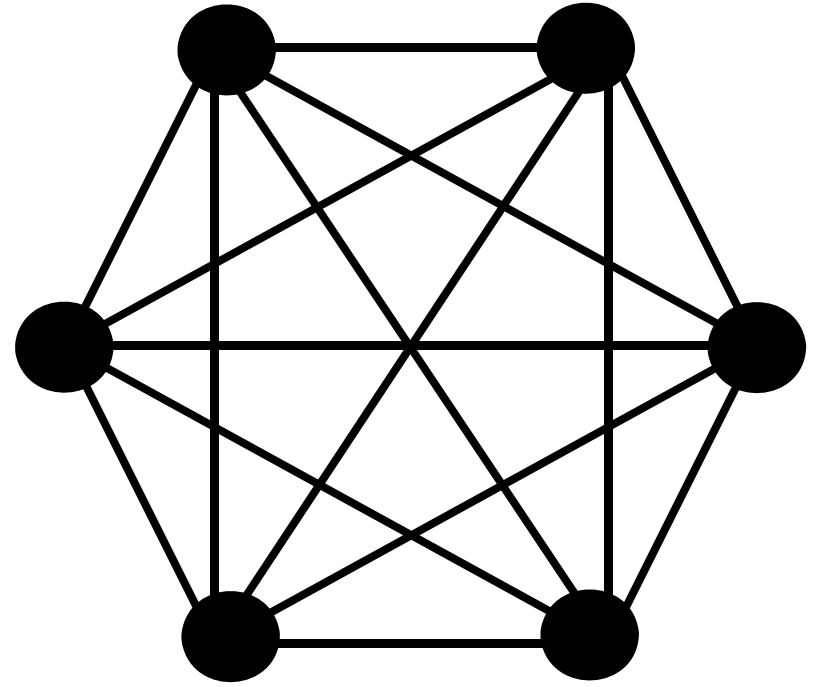

dim=5

# The number of resolving sets of a graph

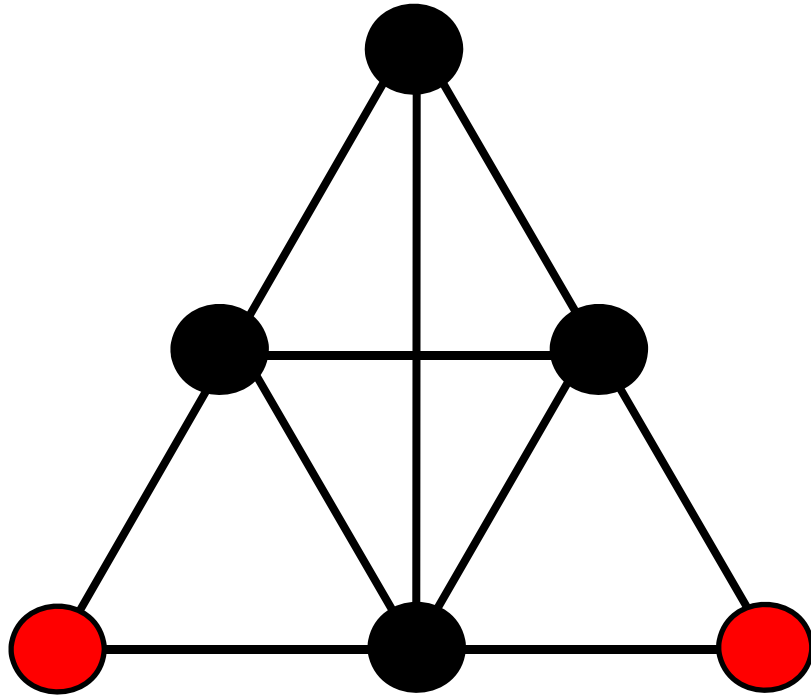

dim=2

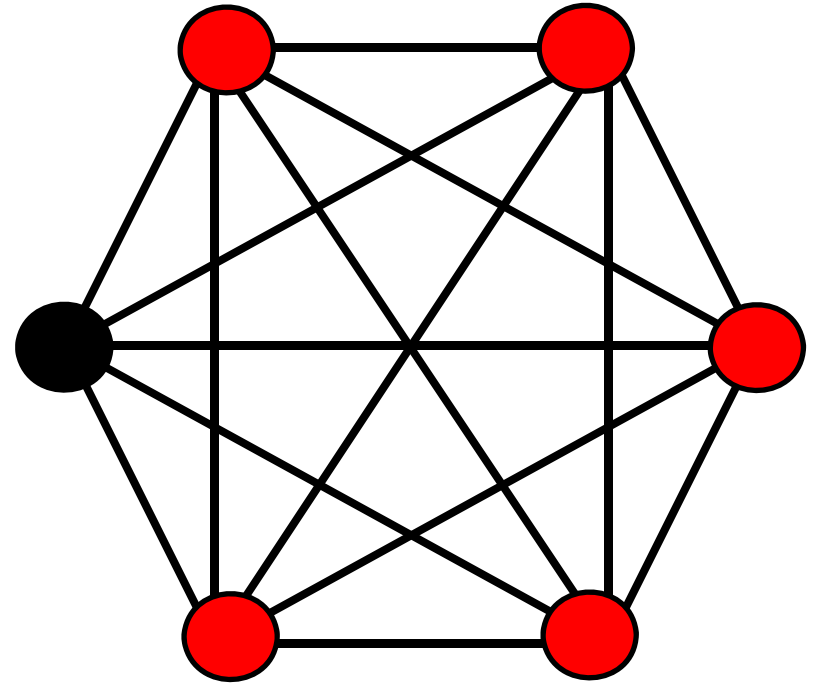

dim=5

# The number of resolving sets of a graph

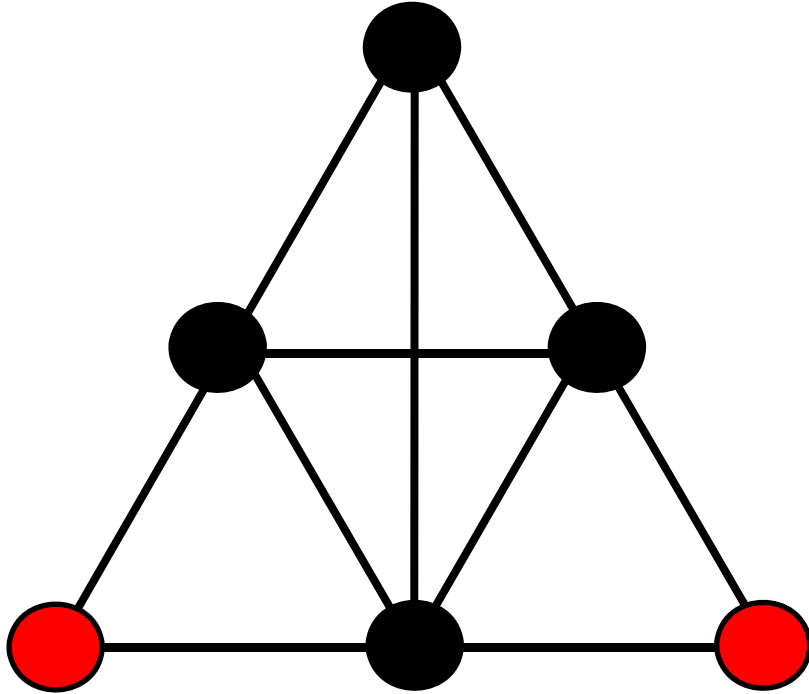

$\dim=2$

$\# \text{ bases}=1$

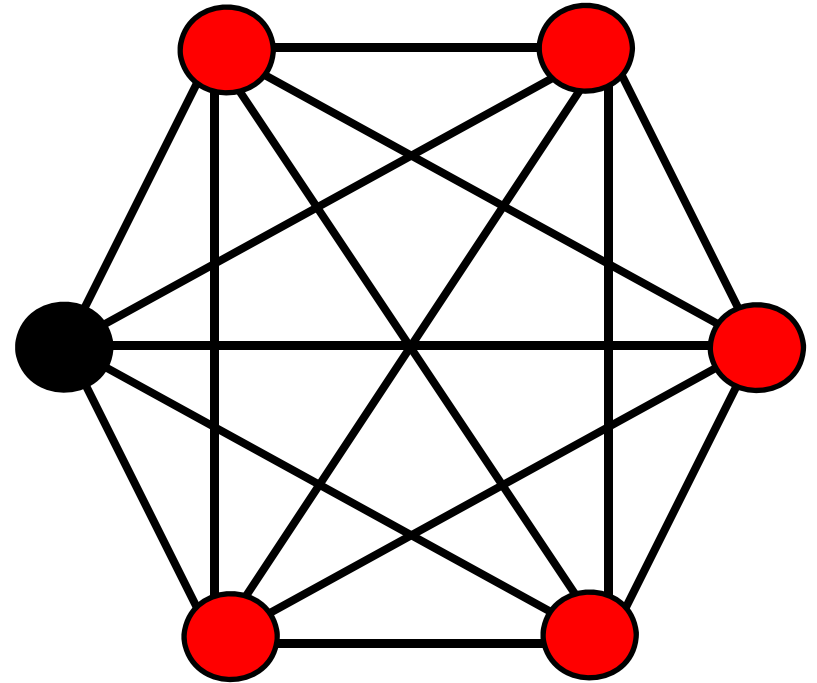

$\dim=5$

$\# \text{ bases}=6$

# Graphs with “many” metric bases



# Graphs with “many” metric bases

Open Problem [Chartrand,Zhang,2000]: Characterize the graphs  $G$  such that every subset of size  $\dim(G)$  is a basis.

# Graphs with “many” metric bases

Open Problem [Chartrand,Zhang,2000]: Characterize the graphs  $G$  such that every subset of size  $\dim(G)$  is a basis.

$$\dim(K_n) = n - 1$$

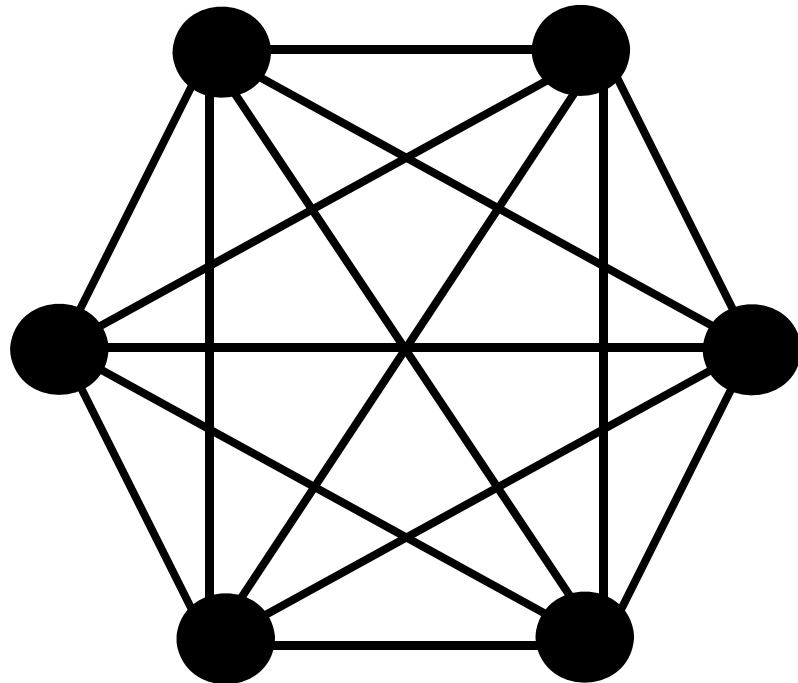

# Graphs with “many” metric bases

Open Problem [Chartrand,Zhang,2000]: Characterize the graphs  $G$  such that every subset of size  $\dim(G)$  is a basis.

$$\dim(K_n) = n - 1$$

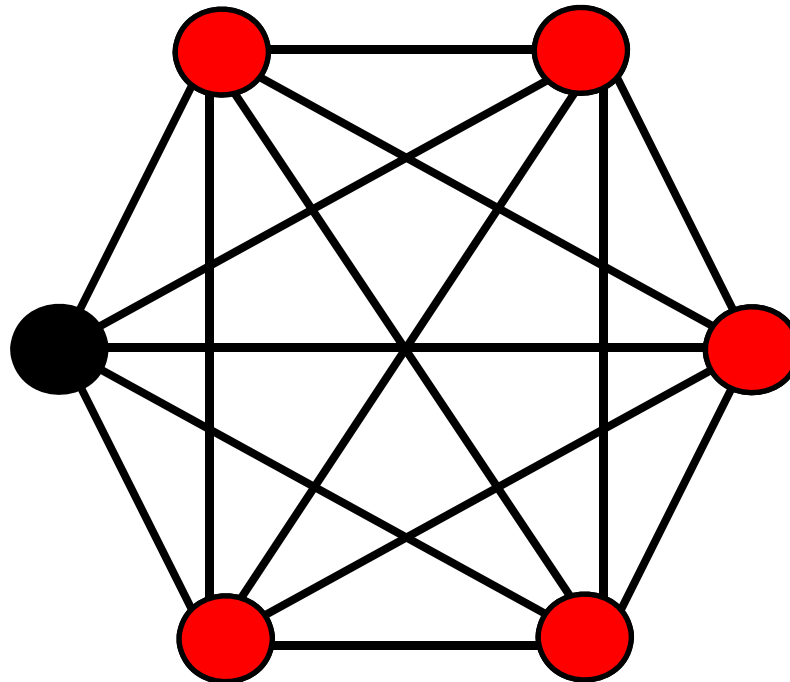

# Graphs with “many” metric bases

Open Problem [Chartrand,Zhang,2000]: Characterize the graphs  $G$  such that every subset of size  $\dim(G)$  is a basis.

$\dim \leq 2$

[Chartrand,Zhang,2000] Complete graphs and odd cycles.

$\dim(K_n) = n - 1$

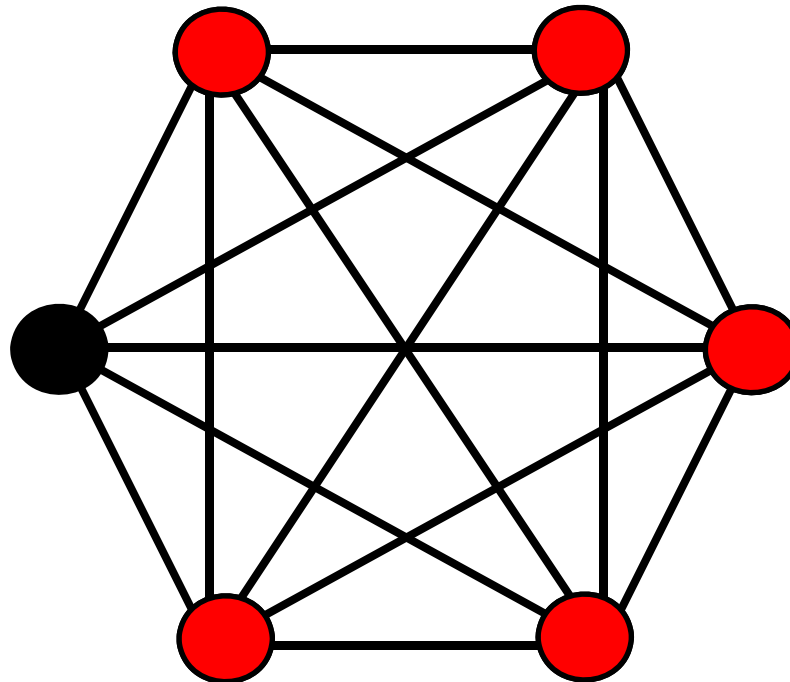

# Graphs with “many” metric bases

Open Problem [Chartrand,Zhang,2000]: Characterize the graphs  $G$  such that every subset of size  $\dim(G)$  is a basis.

$\dim \leq 2$

[Chartrand,Zhang,2000] Complete graphs and odd cycles.

# Graphs with “many” metric bases

Open Problem [Chartrand,Zhang,2000]: Characterize the graphs  $G$  such that every subset of size  $\dim(G)$  is a basis.

$\dim \leq 2$

[Chartrand,Zhang,2000] Complete graphs and odd cycles.

$\dim > 2$

# Graphs with “many” metric bases

Open Problem [Chartrand,Zhang,2000]: Characterize the graphs  $G$  such that every subset of size  $\dim(G)$  is a basis.

$\dim \leq 2$

[Chartrand,Zhang,2000] Complete graphs and odd cycles.

$\dim > 2$

[Garijo,G.,Márquez,2011] Complete graphs.

# Graphs with “many” metric bases

Open Problem [Chartrand,Zhang,2000]: Characterize the graphs  $G$  such that every subset of size  $\dim(G)$  is a basis.

$\dim \leq 2$

[Chartrand,Zhang,2000] Complete graphs and odd cycles.

$\dim > 2$

[Garijo,G.,Márquez,2011] Complete graphs.

Sketch for  $\dim=3$



# Graphs with “many” metric bases

Open Problem [Chartrand,Zhang,2000]: Characterize the graphs  $G$  such that every subset of size  $\dim(G)$  is a basis.

$\dim \leq 2$

[Chartrand,Zhang,2000] Complete graphs and odd cycles.

$\dim > 2$

[Garijo,G.,Márquez,2011] Complete graphs.

Sketch for  $\dim=3$

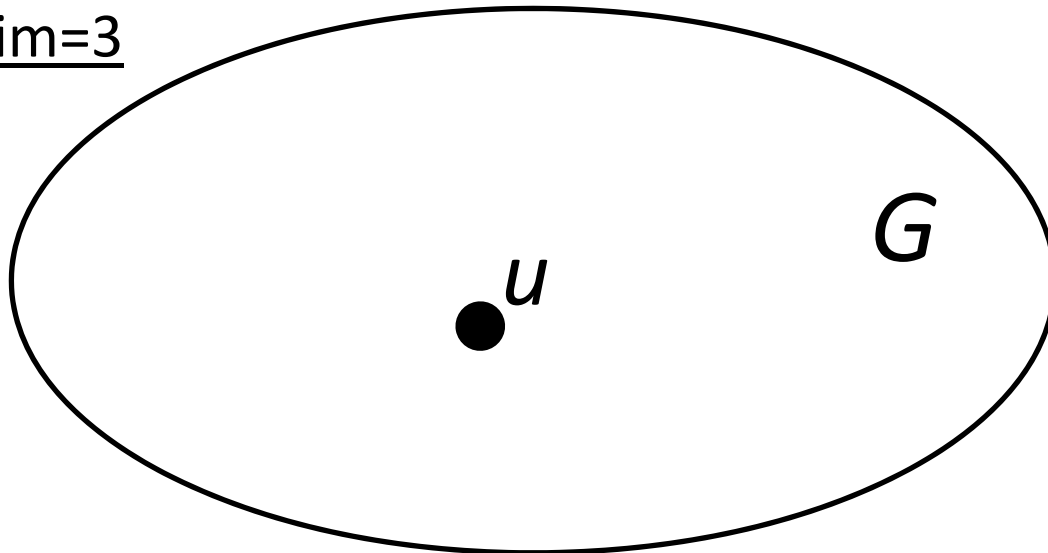

# Graphs with “many” metric bases

Open Problem [Chartrand,Zhang,2000]: Characterize the graphs  $G$  such that every subset of size  $\dim(G)$  is a basis.

$\dim \leq 2$

[Chartrand,Zhang,2000] Complete graphs and odd cycles.

$\dim > 2$

[Garijo,G.,Márquez,2011] Complete graphs.

Sketch for  $\dim=3$

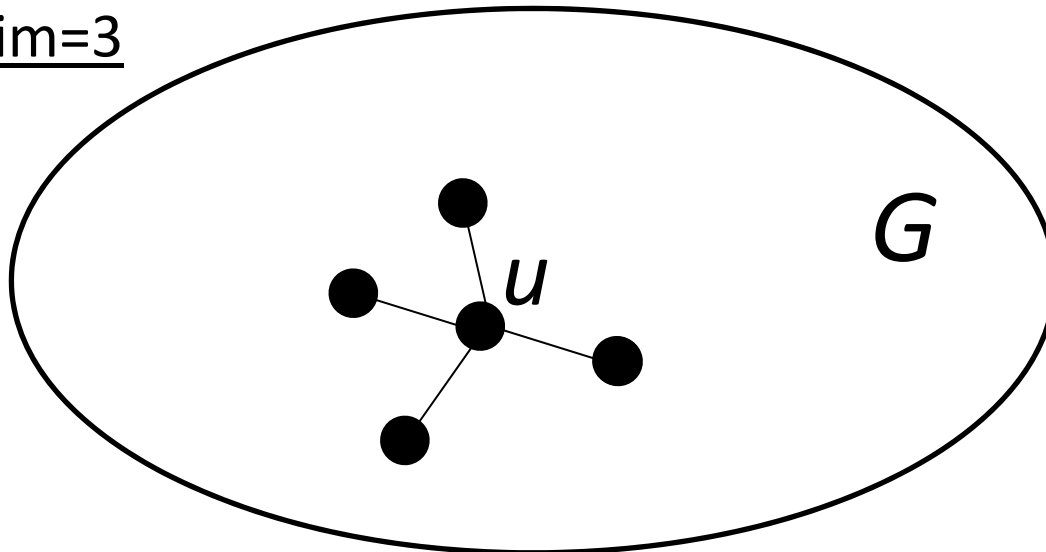

# Graphs with “many” metric bases

Open Problem [Chartrand,Zhang,2000]: Characterize the graphs  $G$  such that every subset of size  $\dim(G)$  is a basis.

$\dim \leq 2$

[Chartrand,Zhang,2000] Complete graphs and odd cycles.

$\dim > 2$

[Garijo,G.,Márquez,2011] Complete graphs.

Sketch for  $\dim=3$

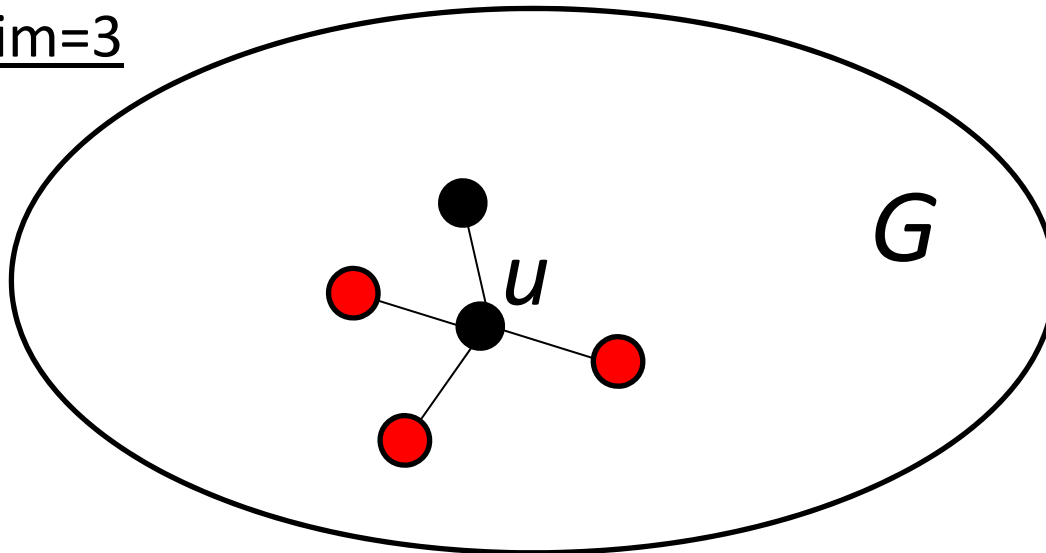

# Graphs with “many” metric bases

Open Problem [Chartrand,Zhang,2000]: Characterize the graphs  $G$  such that every subset of size  $\dim(G)$  is a basis.

$\dim \leq 2$

[Chartrand,Zhang,2000] Complete graphs and odd cycles.

$\dim > 2$

[Garijo,G.,Márquez,2011] Complete graphs.

Sketch for  $\dim=3$

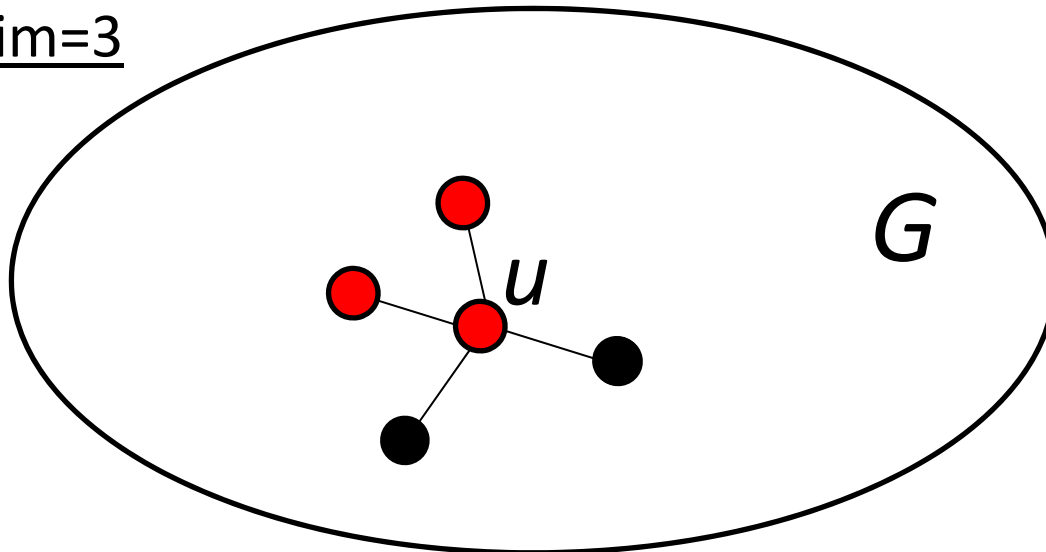

# Graphs with “many” metric bases

Open Problem [Chartrand,Zhang,2000]: Characterize the graphs  $G$  such that every subset of size  $\dim(G)$  is a basis.

$\dim \leq 2$

[Chartrand,Zhang,2000] Complete graphs and odd cycles.

$\dim > 2$

[Garijo,G.,Márquez,2011] Complete graphs.

Sketch for  $\dim=3$

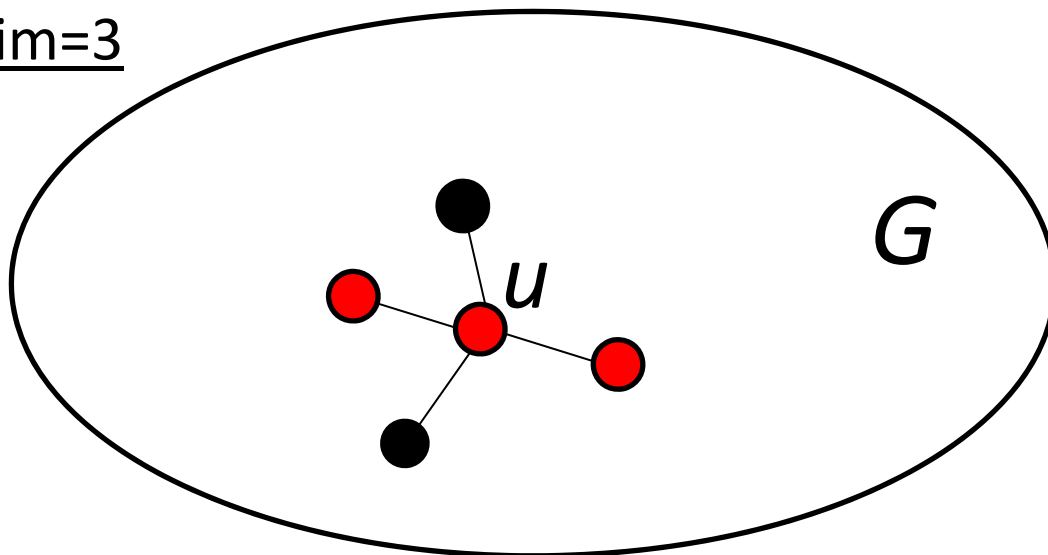

# Graphs with “many” metric bases

Open Problem [Chartrand,Zhang,2000]: Characterize the graphs  $G$  such that every subset of size  $\dim(G)$  is a basis.

$\dim \leq 2$

[Chartrand,Zhang,2000] Complete graphs and odd cycles.

$\dim > 2$

[Garijo,G.,Márquez,2011] Complete graphs.

Sketch for  $\dim=3$

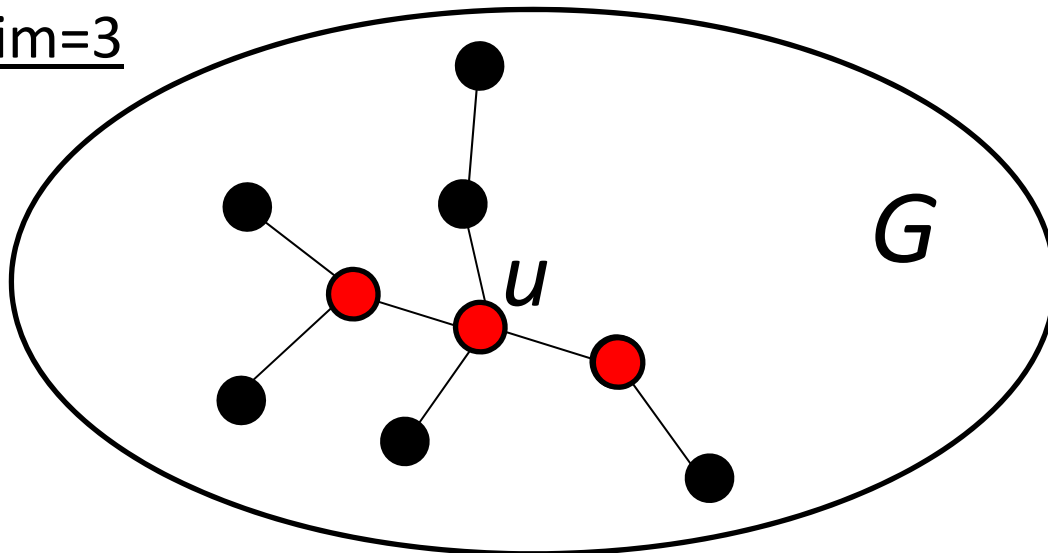

# Graphs with “many” metric bases

Open Problem [Chartrand,Zhang,2000]: Characterize the graphs  $G$  such that every subset of size  $\dim(G)$  is a basis.

$\dim \leq 2$

[Chartrand,Zhang,2000] Complete graphs and odd cycles.

$\dim > 2$

[Garijo,G.,Márquez,2011] Complete graphs.

Sketch for  $\dim=3$

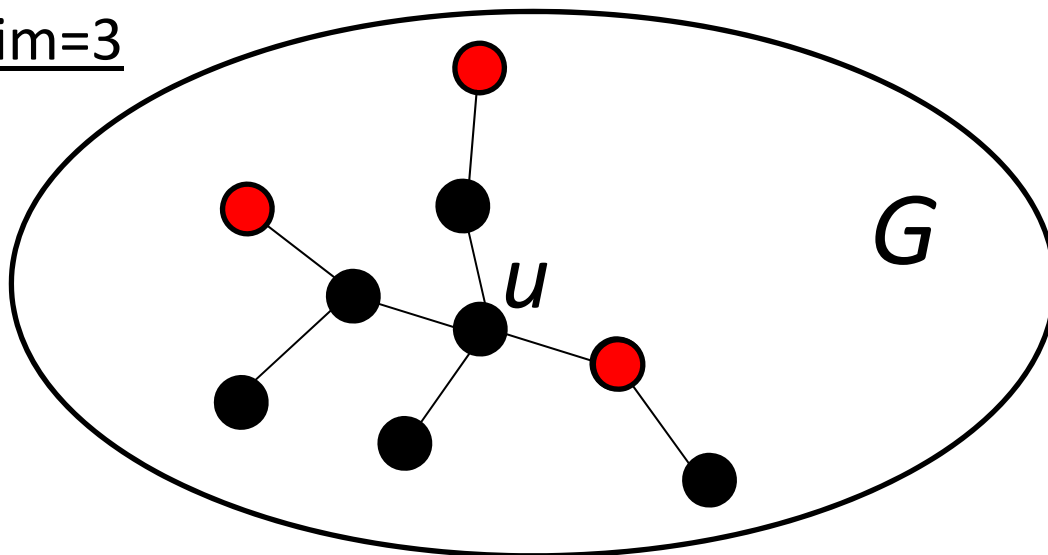

# Graphs with “many” metric bases

Open Problem [Chartrand,Zhang,2000]: Characterize the graphs  $G$  such that every subset of size  $\dim(G)$  is a basis.

$\dim \leq 2$

[Chartrand,Zhang,2000] Complete graphs and odd cycles.

$\dim > 2$

[Garijo,G.,Márquez,2011] Complete graphs.

Sketch for  $\dim=3$

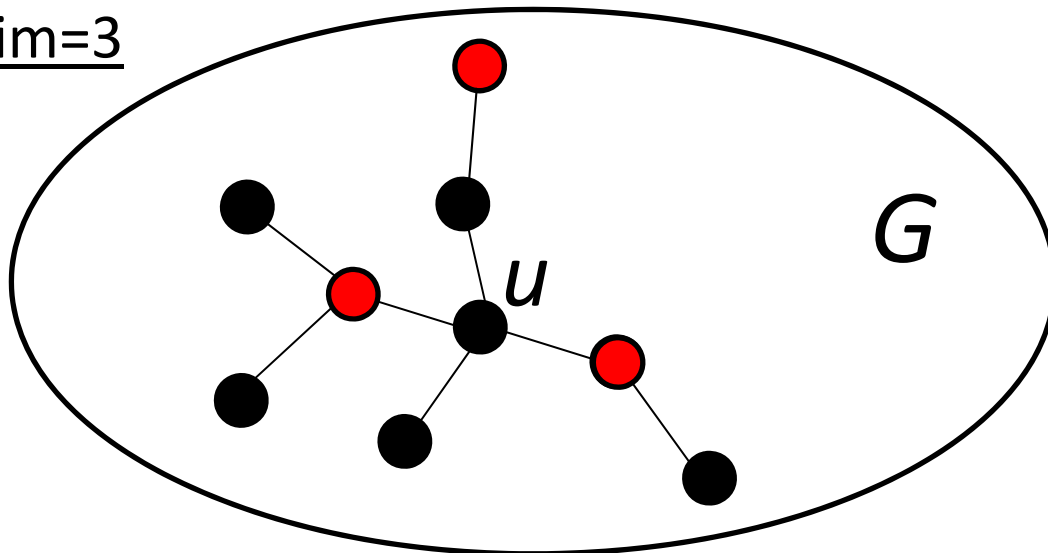



# Graphs with “many” metric bases

Open Problem [Chartrand,Zhang,2000]: Characterize the graphs  $G$  such that every subset of size  $\dim(G)$  is a basis.

$\dim \leq 2$

[Chartrand,Zhang,2000] Complete graphs and odd cycles.

$\dim > 2$

[Garijo,G.,Márquez,2011] Complete graphs.

Sketch for  $\dim=3$

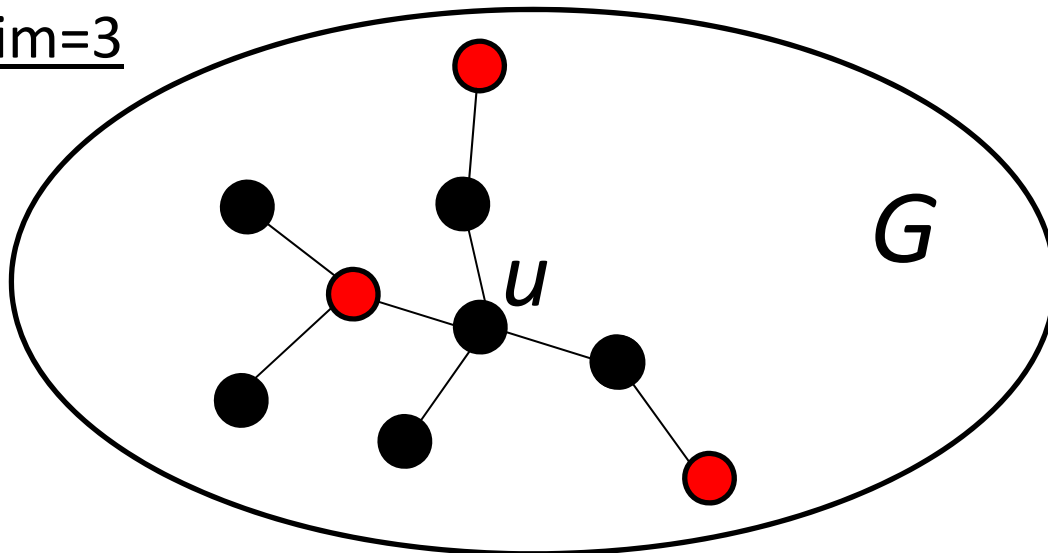

# Graphs with “many” metric bases

Open Problem [Chartrand,Zhang,2000]: Characterize the graphs  $G$  such that every subset of size  $\dim(G)$  is a basis.

$\dim \leq 2$

[Chartrand,Zhang,2000] Complete graphs and odd cycles.

$\dim > 2$

[Garijo,G.,Márquez,2011] Complete graphs.

Sketch for  $\dim=3$

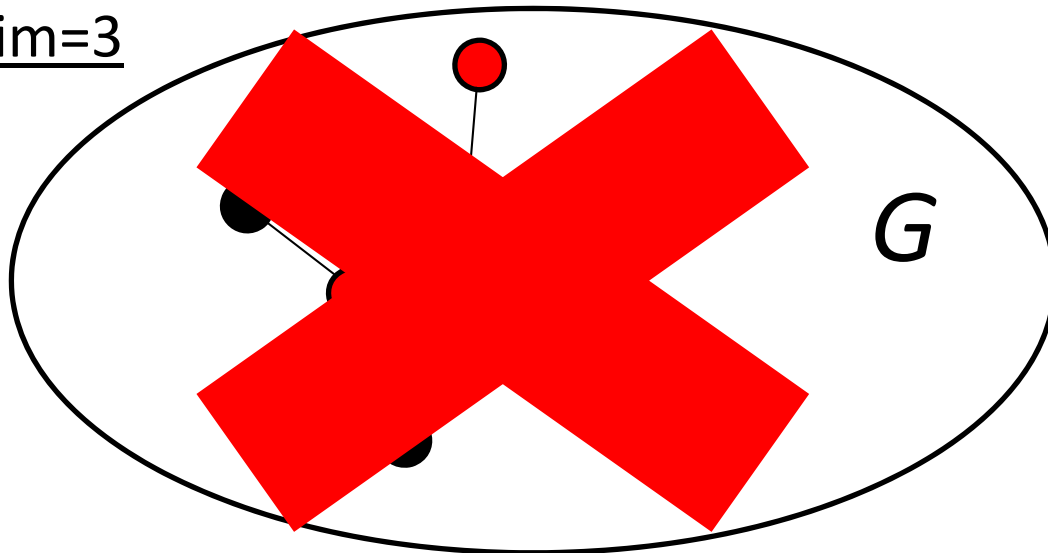

# Graphs with “many” metric bases

Open Problem [Chartrand,Zhang,2000]: Characterize the graphs  $G$  such that every subset of size  $\dim(G)$  is a basis.

$\dim \leq 2$

[Chartrand,Zhang,2000] Complete graphs and odd cycles.

$\dim > 2$

[Garijo,G.,Márquez,2011] Complete graphs.

Sketch for  $\dim=3$

# Graphs with “many” metric bases

Open Problem [Chartrand,Zhang,2000]: Characterize the graphs  $G$  such that every subset of size  $\dim(G)$  is a basis.

$\dim \leq 2$

[Chartrand,Zhang,2000] Complete graphs and odd cycles.

$\dim > 2$

[Garijo,G.,Márquez,2011] Complete graphs.

Sketch for  $\dim=3$

$\mathcal{P}_2(V)$



$\mathcal{P}_2(V)$



# Graphs with “many” metric bases

Open Problem [Chartrand,Zhang,2000]: Characterize the graphs  $G$  such that every subset of size  $\dim(G)$  is a basis.

$\dim \leq 2$

[Chartrand,Zhang,2000] Complete graphs and odd cycles.

$\dim > 2$

[Garijo,G.,Márquez,2011] Complete graphs.

Sketch for  $\dim=3$

$\mathcal{P}_2(V)$

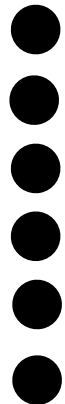

NON-BASES

$\mathcal{P}_2(V)$



NON-DISTINGUISHED  
PAIRS

# Graphs with “many” metric bases

Open Problem [Chartrand,Zhang,2000]: Characterize the graphs  $G$  such that every subset of size  $\dim(G)$  is a basis.

$\dim \leq 2$

[Chartrand,Zhang,2000] Complete graphs and odd cycles.

$\dim > 2$

[Garijo,G.,Márquez,2011] Complete graphs.

Sketch for  $\dim=3$

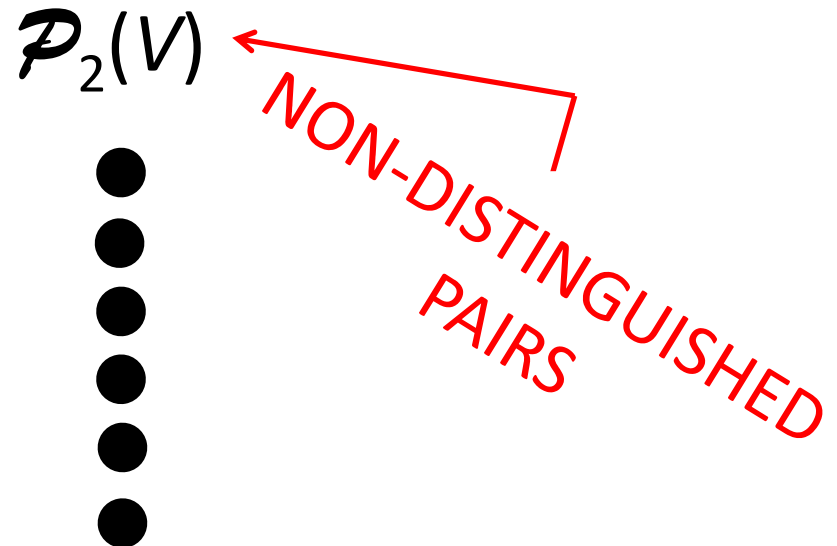
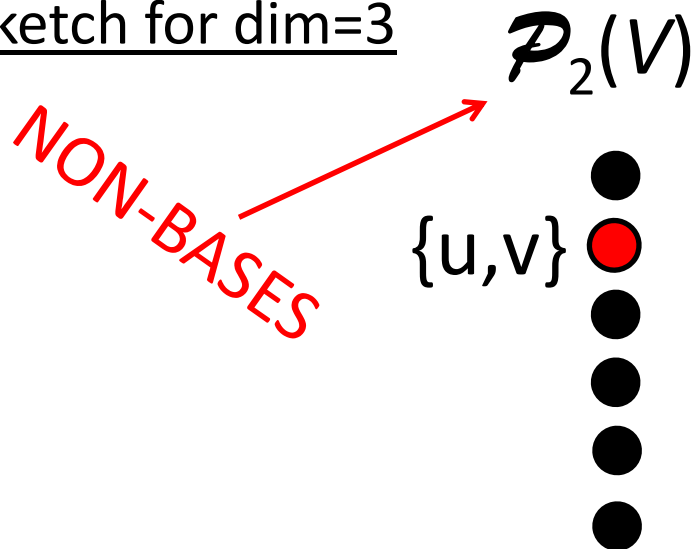

# Graphs with “many” metric bases

Open Problem [Chartrand,Zhang,2000]: Characterize the graphs  $G$  such that every subset of size  $\dim(G)$  is a basis.

$\dim \leq 2$

[Chartrand,Zhang,2000] Complete graphs and odd cycles.

$\dim > 2$

[Garijo,G.,Márquez,2011] Complete graphs.

Sketch for  $\dim=3$

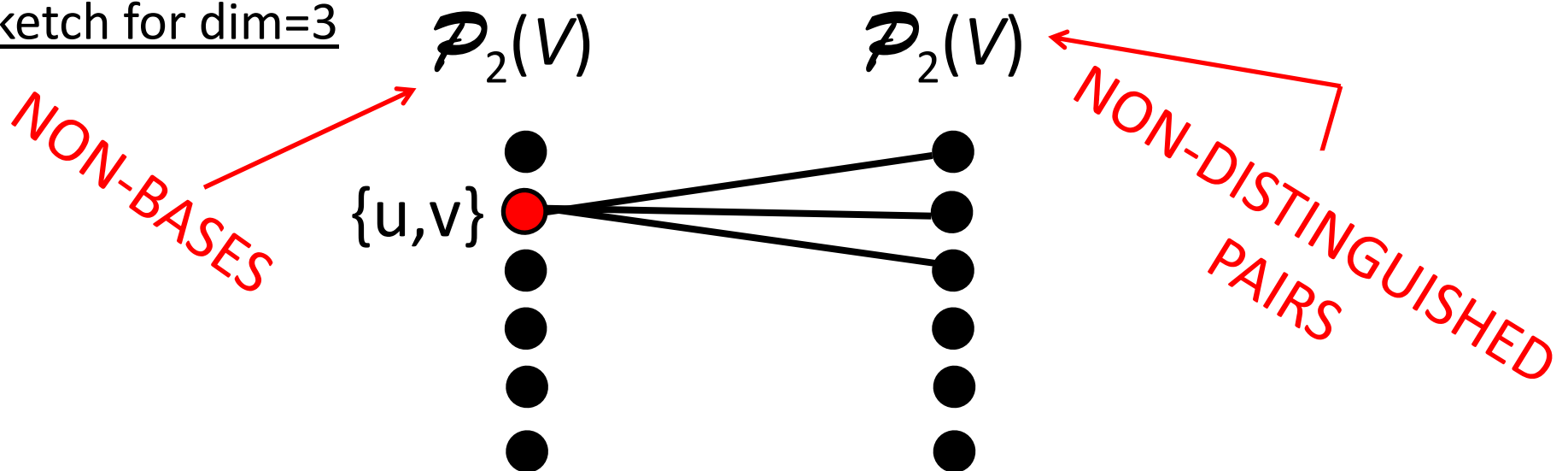

# Graphs with “many” metric bases

Open Problem [Chartrand,Zhang,2000]: Characterize the graphs  $G$  such that every subset of size  $\dim(G)$  is a basis.

$\dim \leq 2$

[Chartrand,Zhang,2000] Complete graphs and odd cycles.

$\dim > 2$

[Garijo,G.,Márquez,2011] Complete graphs.

Sketch for  $\dim=3$

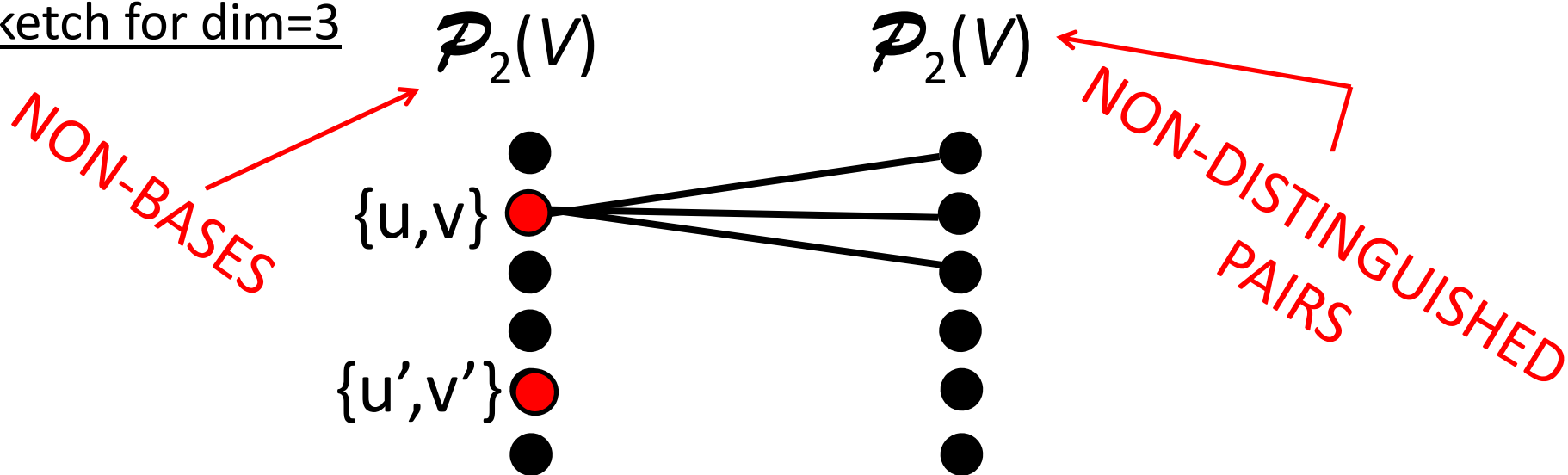



# Graphs with “many” metric bases

Open Problem [Chartrand,Zhang,2000]: Characterize the graphs  $G$  such that every subset of size  $\dim(G)$  is a basis.

$\dim \leq 2$

[Chartrand,Zhang,2000] Complete graphs and odd cycles.

$\dim > 2$

[Garijo,G.,Márquez,2011] Complete graphs.

Sketch for  $\dim=3$

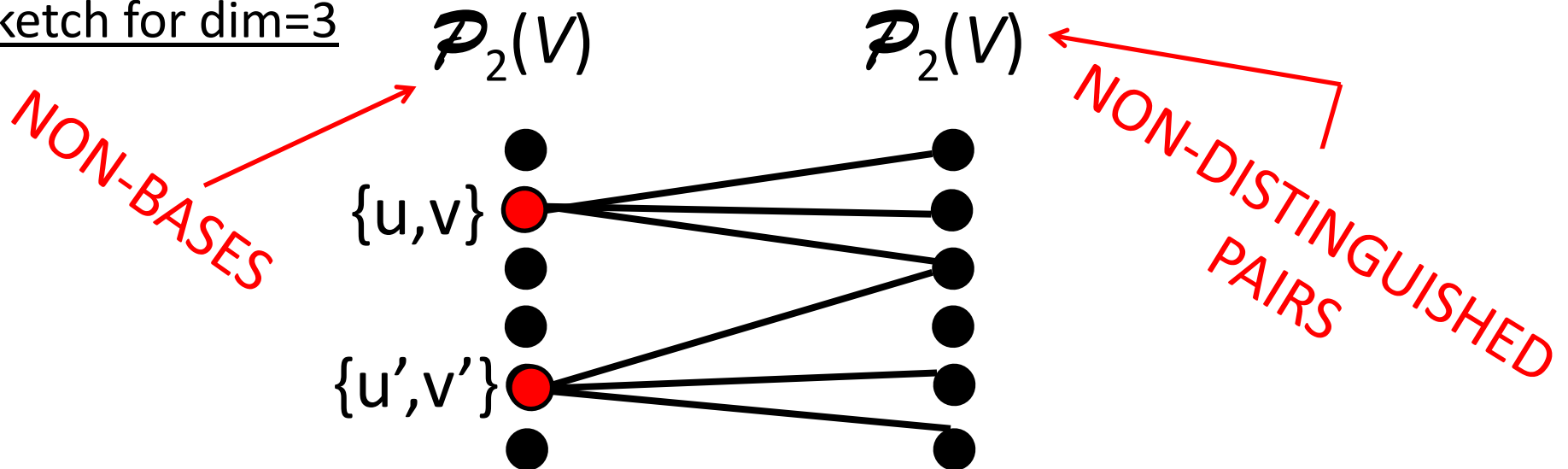

# Graphs with “many” metric bases

Open Problem [Chartrand,Zhang,2000]: Characterize the graphs  $G$  such that every subset of size  $\dim(G)$  is a basis.

$\dim \leq 2$

[Chartrand,Zhang,2000] Complete graphs and odd cycles.

$\dim > 2$

[Garijo,G.,Márquez,2011] Complete graphs.

Sketch for  $\dim=3$

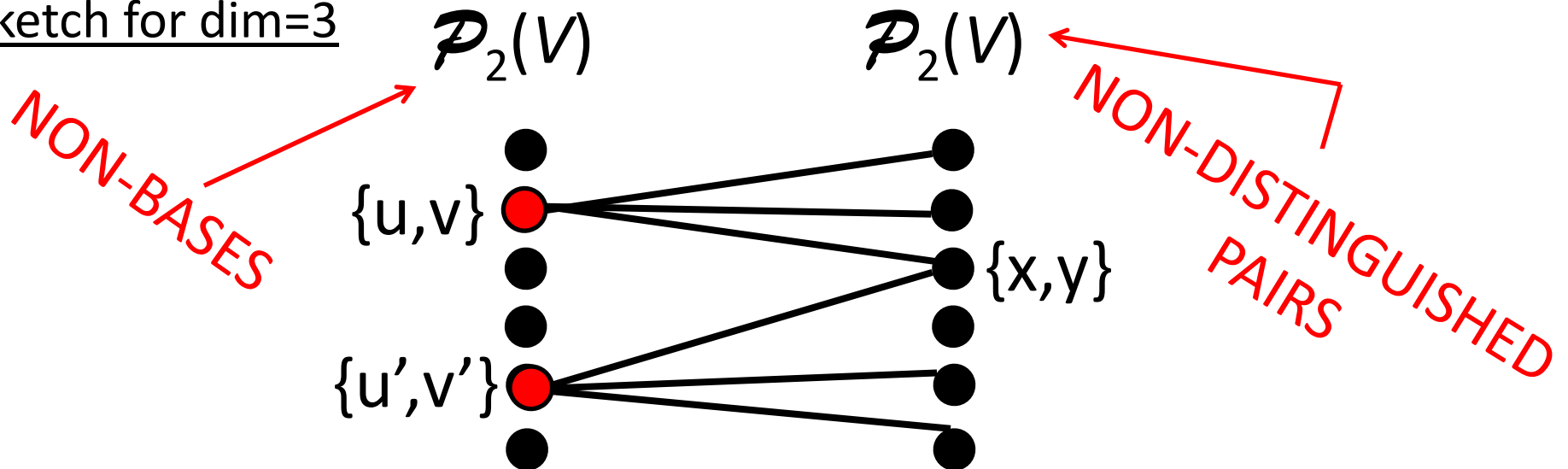

# Graphs with “many” metric bases

Open Problem [Chartrand,Zhang,2000]: Characterize the graphs  $G$  such that every subset of size  $\dim(G)$  is a basis.

$\dim \leq 2$

[Chartrand,Zhang,2000] Complete graphs and odd cycles.

$\dim > 2$

[Garijo,G.,Márquez,2011] Complete graphs.

Sketch for  $\dim=3$

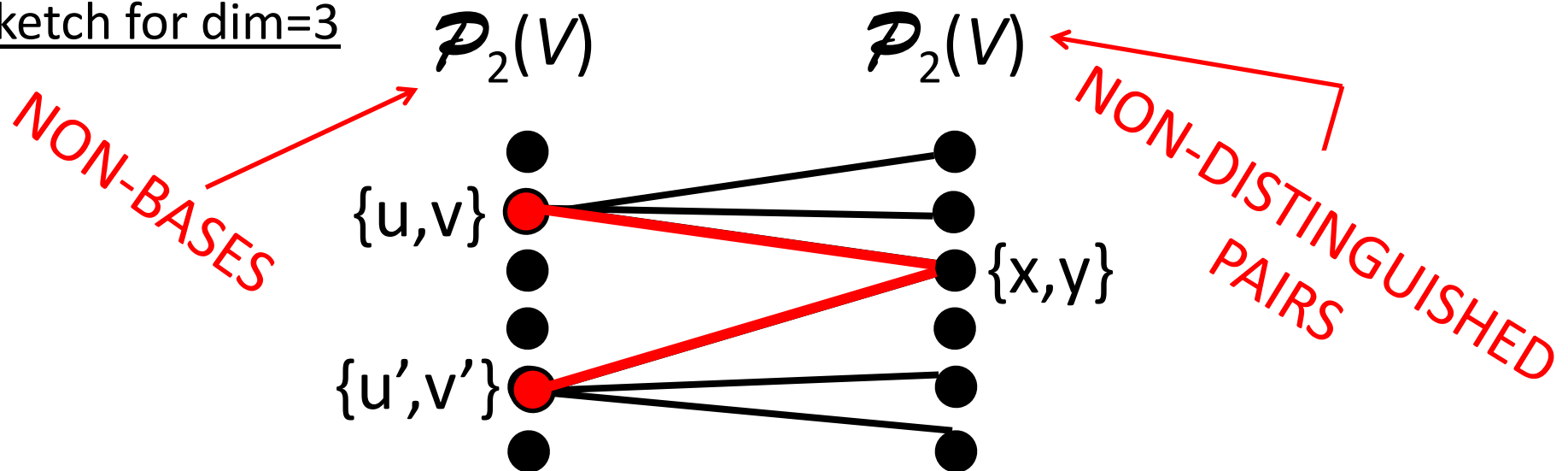

# Graphs with “many” metric bases

Open Problem [Chartrand,Zhang,2000]: Characterize the graphs  $G$  such that every subset of size  $\dim(G)$  is a basis.

$\dim \leq 2$

[Chartrand,Zhang,2000] Complete graphs and odd cycles.

$\dim > 2$

[Garijo,G.,Márquez,2011] Complete graphs.

Sketch for  $\dim=3$

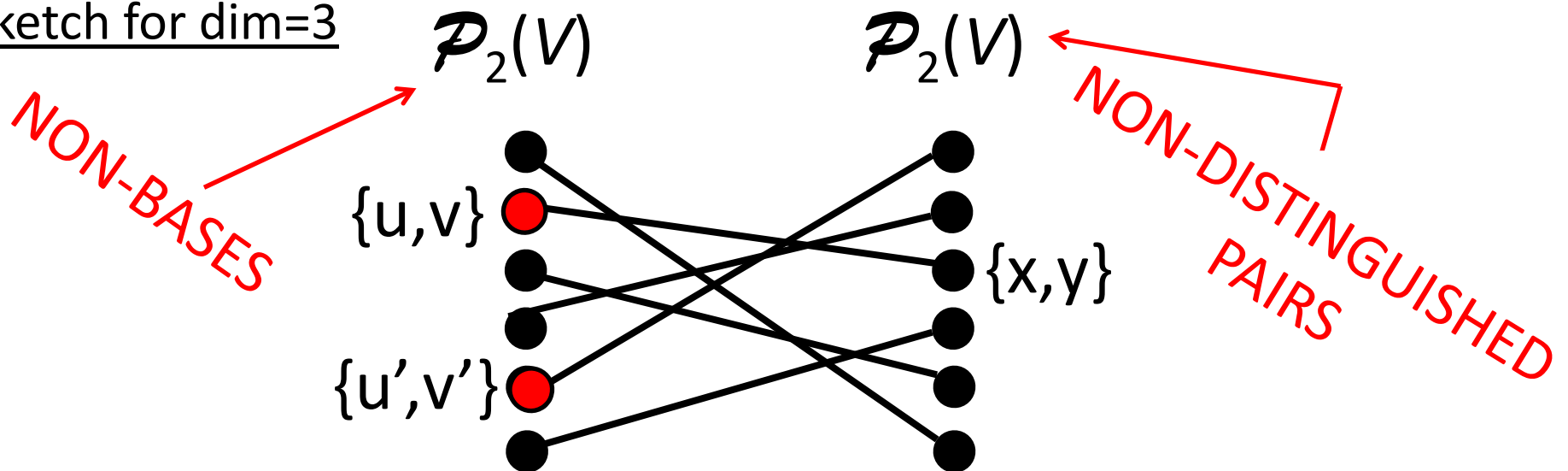

# Graphs with “many” metric bases

Open Problem [Chartrand,Zhang,2000]: Characterize the graphs  $G$  such that every subset of size  $\dim(G)$  is a basis.

$\dim \leq 2$

[Chartrand,Zhang,2000] Complete graphs and odd cycles.

$\dim > 2$

[Garijo,G.,Márquez,2011] Complete graphs.

Sketch for  $\dim=3$

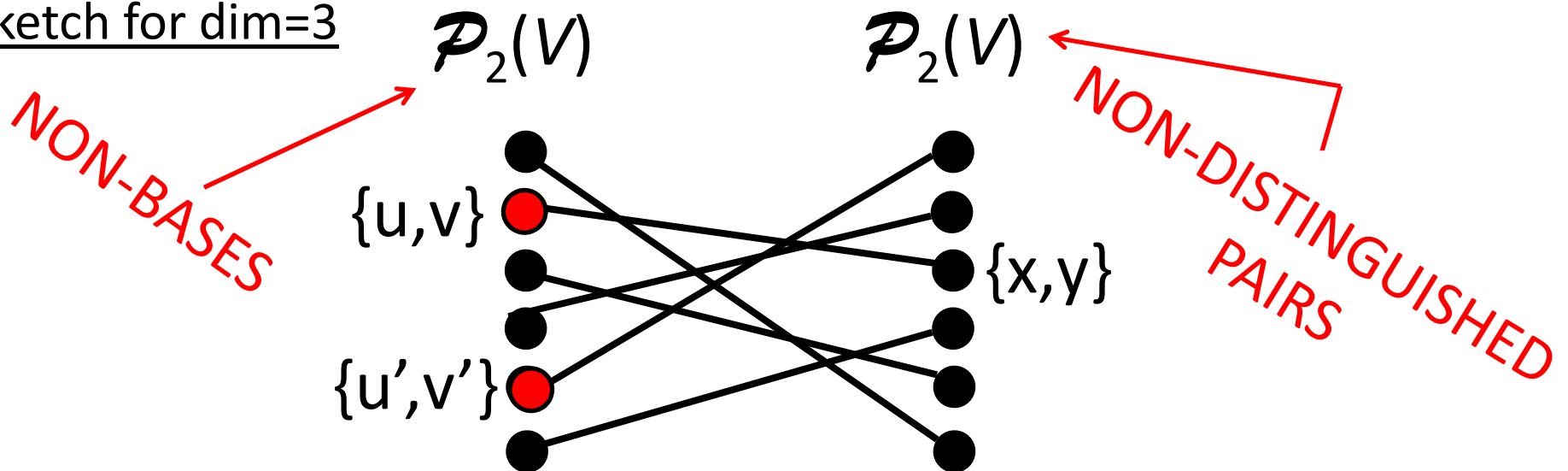

# Graphs with “many” metric bases

Open Problem [Chartrand,Zhang,2000]: Characterize the graphs  $G$  such that every subset of size  $\dim(G)$  is a basis.

$\dim \leq 2$

[Chartrand,Zhang,2000] Complete graphs and odd cycles.

$\dim > 2$

[Garijo,G.,Márquez,2011] Complete graphs.

Sketch for  $\dim=3$

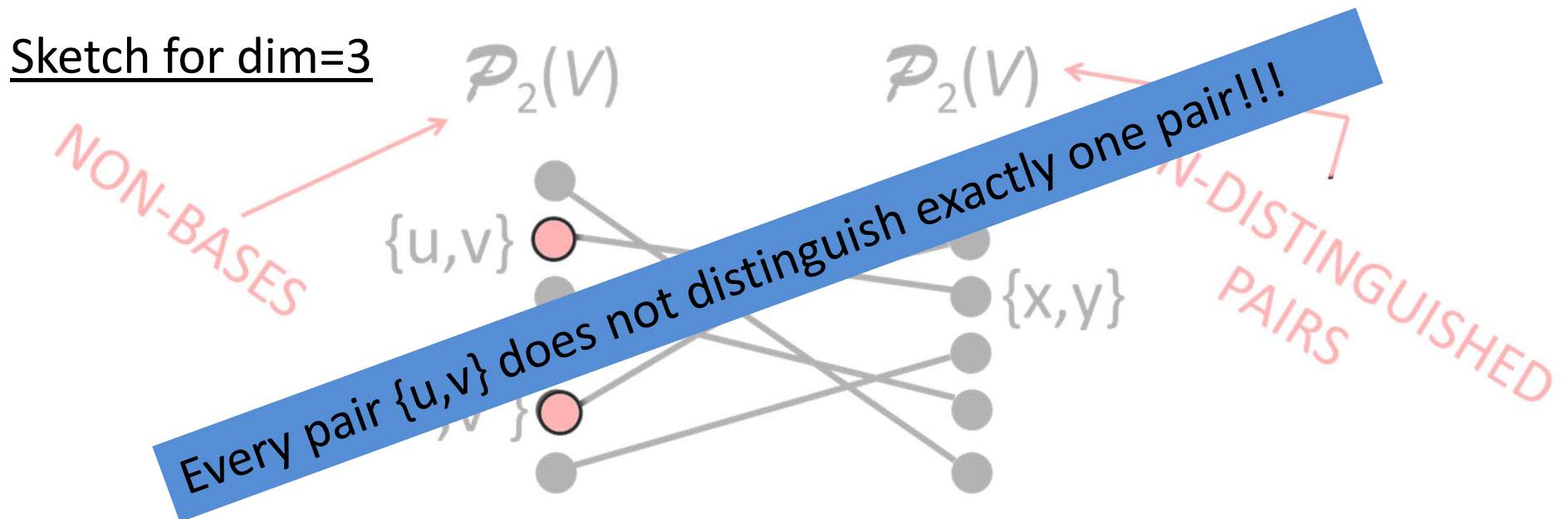

# Upper Dimension and Resolving Number

# Upper Dimension and Resolving Number

$\dim^+(G)$  = maximum size of a minimal resolving set



# Upper Dimension and Resolving Number

$\dim^+(G)$  = maximum size of a minimal resolving set

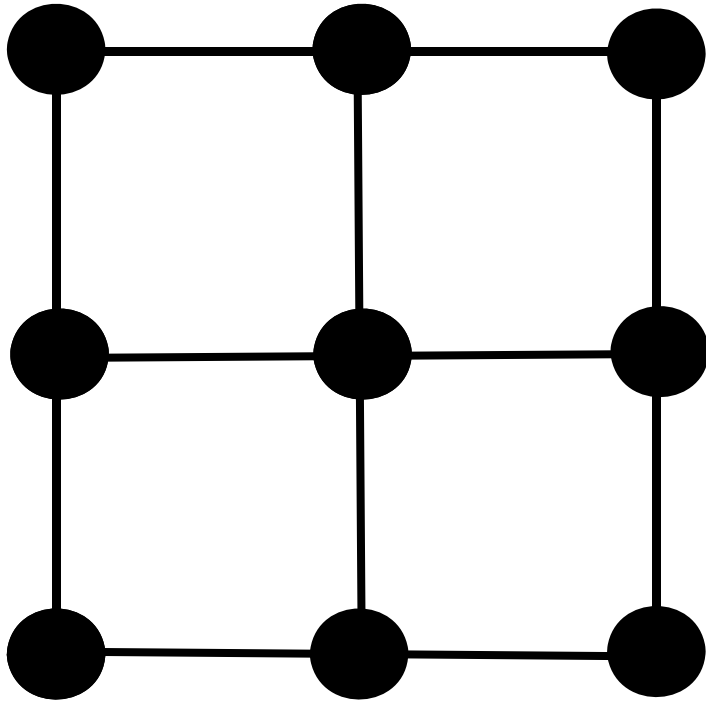

# Upper Dimension and Resolving Number

$\dim^+(G)$  = maximum size of a minimal resolving set

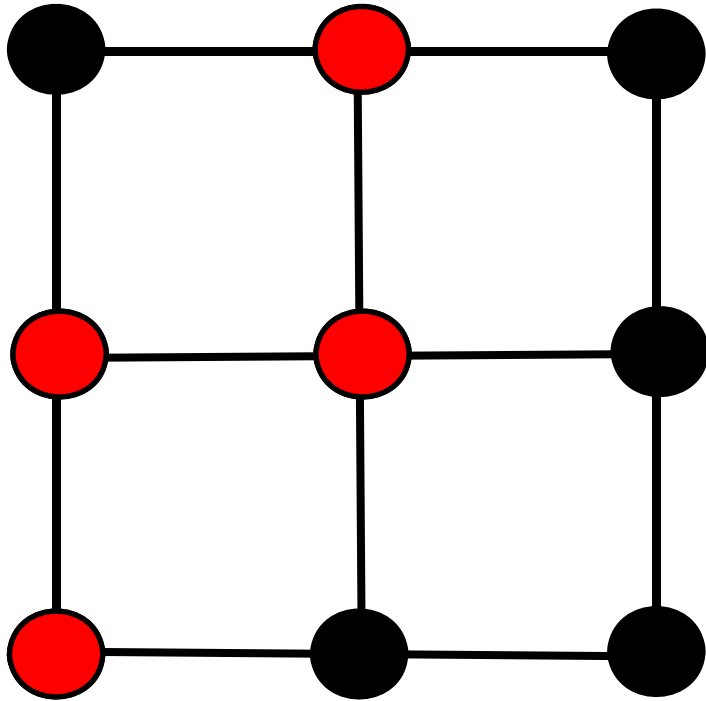

# Upper Dimension and Resolving Number

$\dim^+(G)$  = maximum size of a minimal resolving set

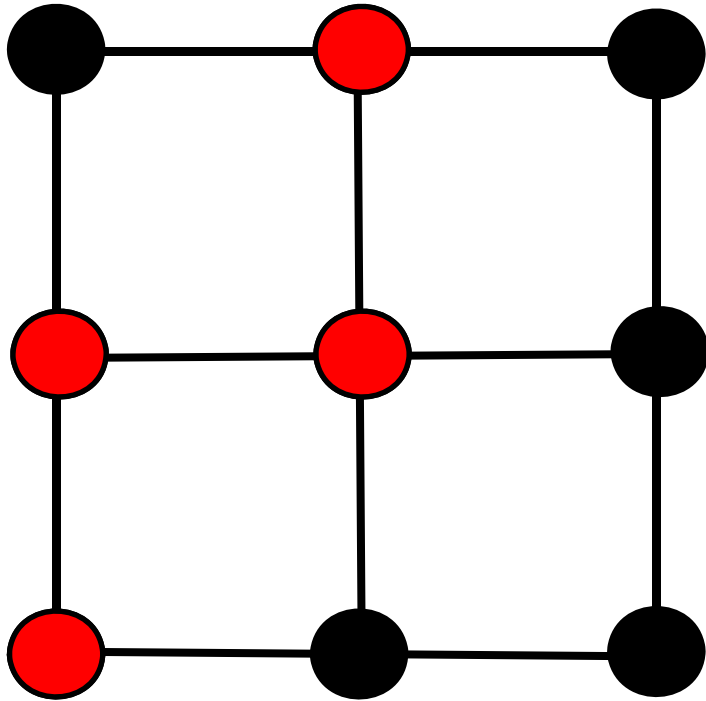

$\dim^+(G)=4$

# Upper Dimension and Resolving Number

$\dim^+(G)$  = maximum size of a minimal resolving set

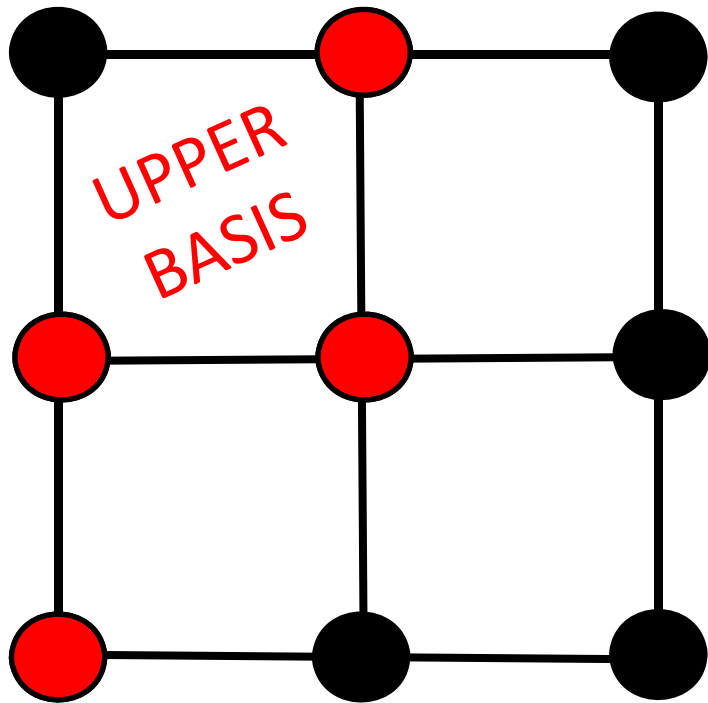

$$\dim^+(G)=4$$

# Upper Dimension and Resolving Number

$\dim^+(G)$  = maximum size of a minimal resolving set

$\text{res}(G)$  = The minimum  $k$  such that every  $k$ -subset is a resolving set.

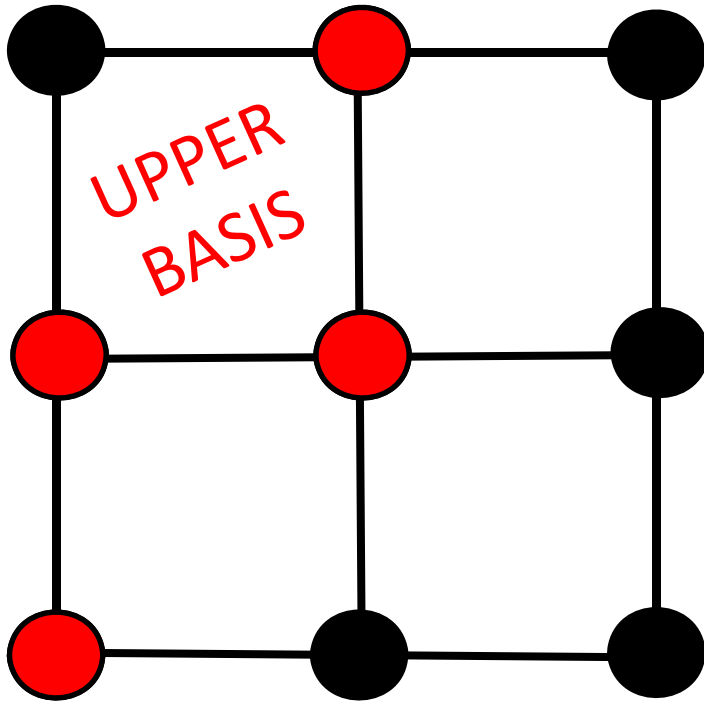

$\dim^+(G) = 4$

# Upper Dimension and Resolving Number

$\dim^+(G)$  = maximum size of a minimal resolving set

$\text{res}(G)$  = The minimum  $k$  such that every  $k$ -subset is a resolving set.

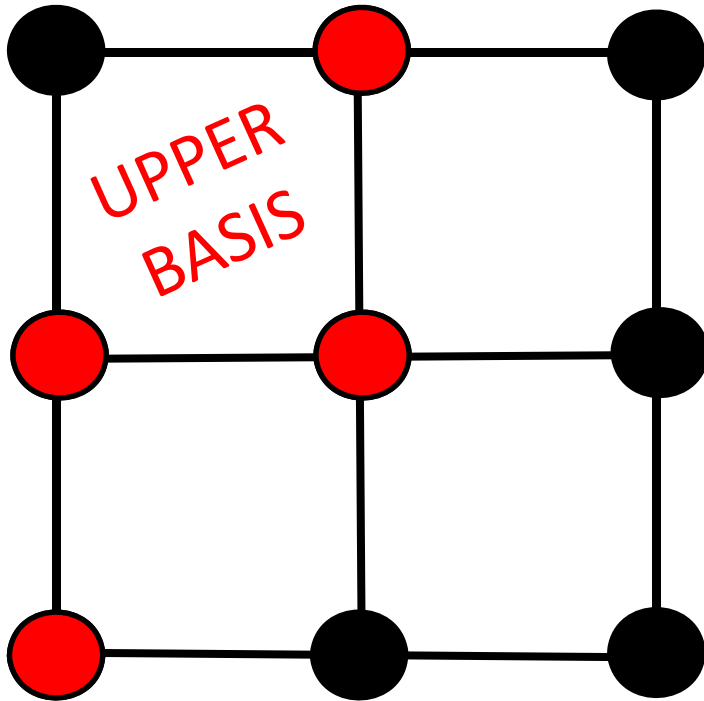

$\dim^+(G) = 4$

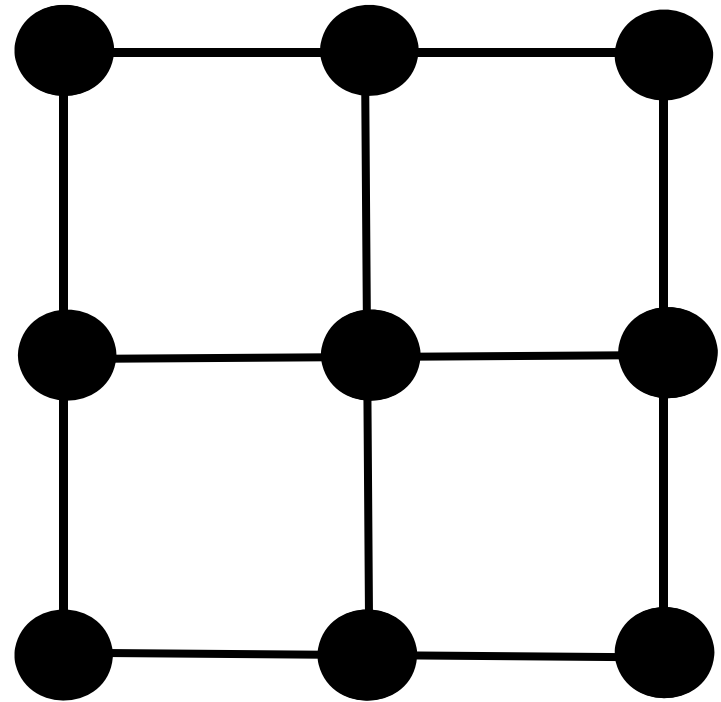

# Upper Dimension and Resolving Number

$\dim^+(G)$  = maximum size of a minimal resolving set

$\text{res}(G)$  = The minimum  $k$  such that every  $k$ -subset is a resolving set.

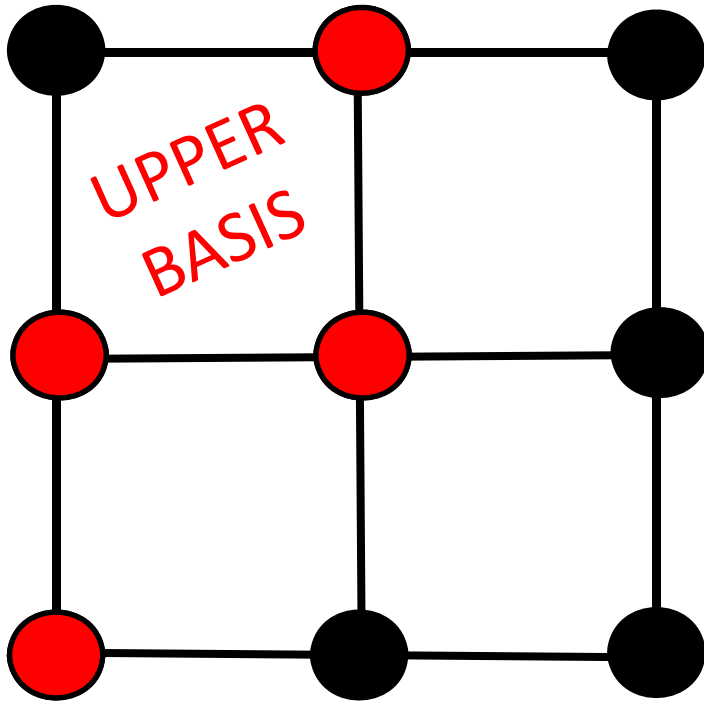

$\dim^+(G) = 4$

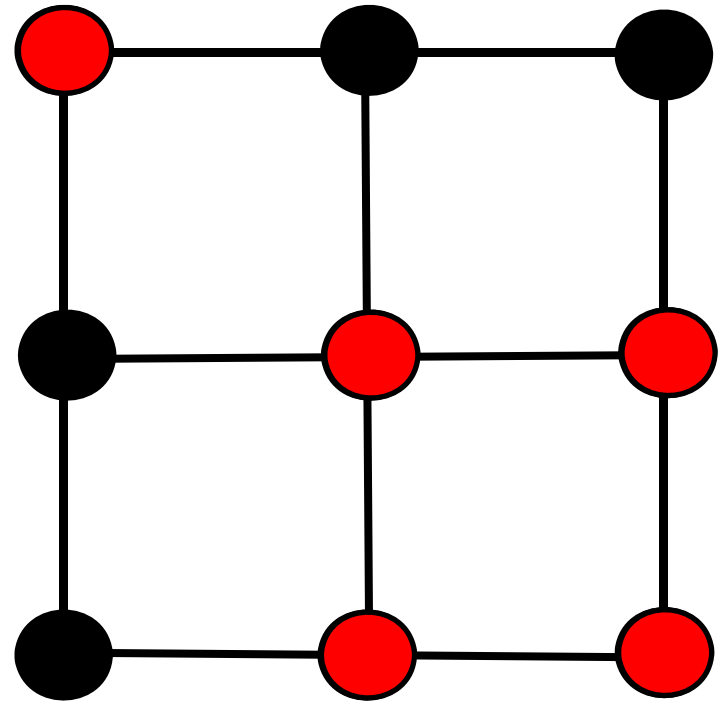

# Upper Dimension and Resolving Number

$\dim^+(G)$  = maximum size of a minimal resolving set

$\text{res}(G)$  = The minimum  $k$  such that every  $k$ -subset is a resolving set.

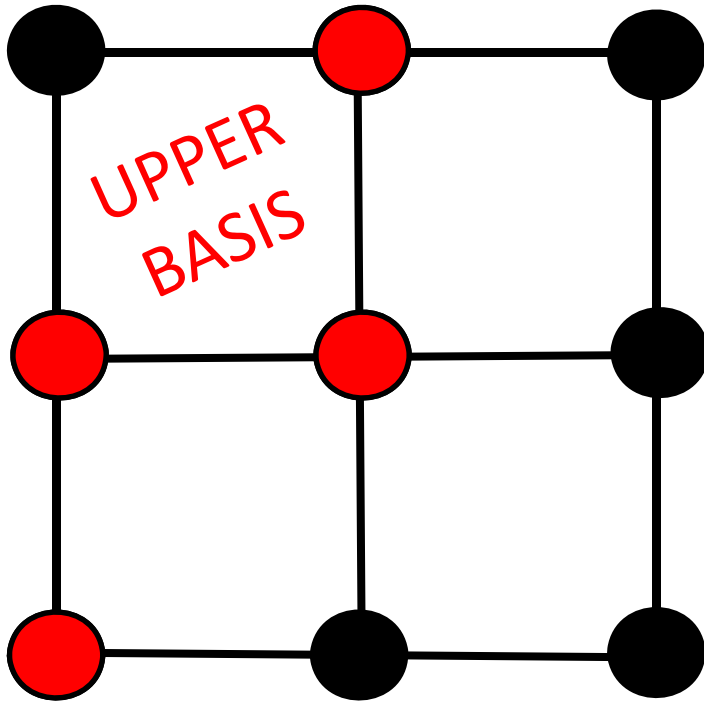

$\dim^+(G)=4$

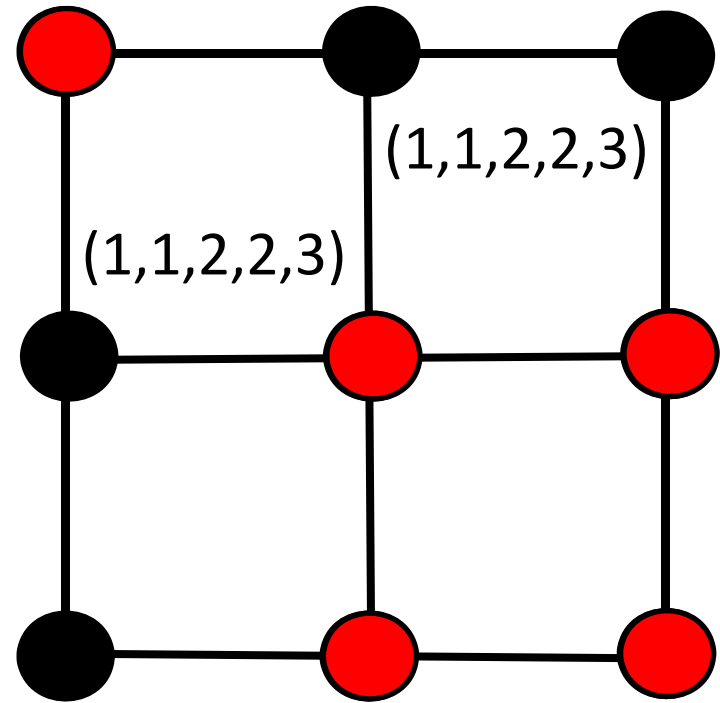



# Upper Dimension and Resolving Number

$\dim^+(G)$  = maximum size of a minimal resolving set

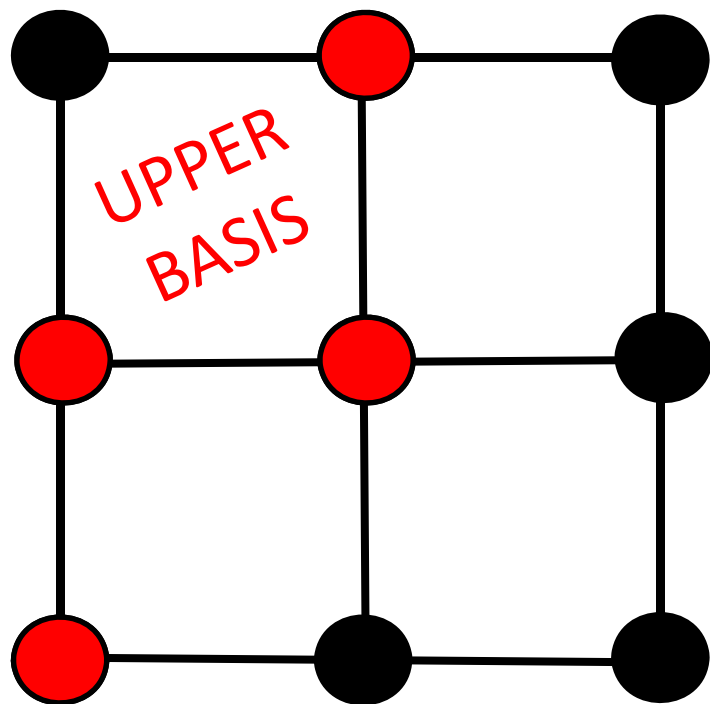

$$\dim^+(G) = 4$$

$\text{res}(G)$  = The minimum  $k$  such that every  $k$ -subset is a resolving set.

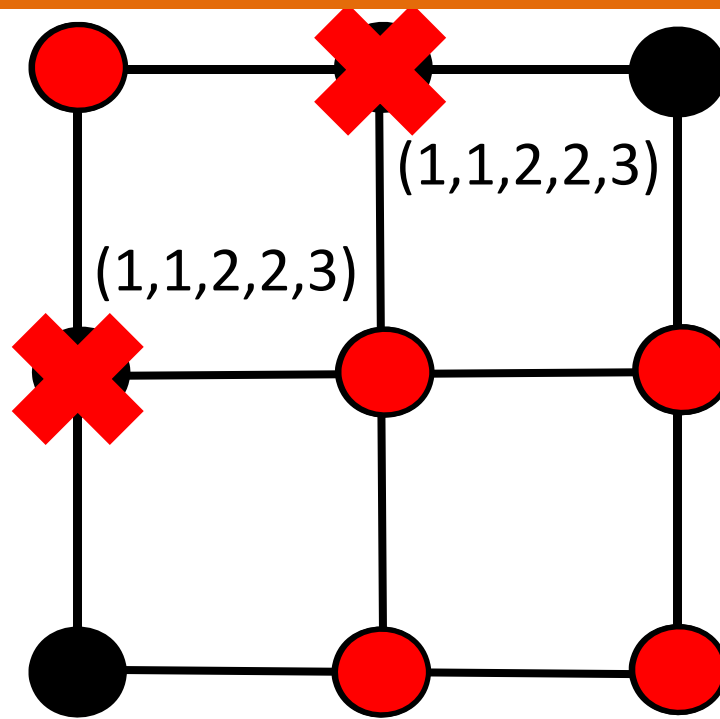

# Upper Dimension and Resolving Number

$\dim^+(G)$  = maximum size of a minimal resolving set

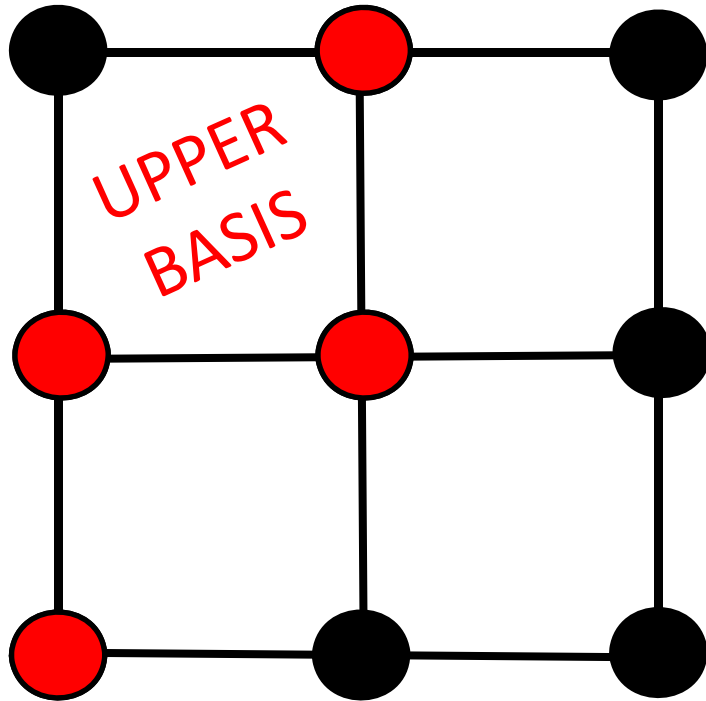

$$\dim^+(G) = 4$$

$\text{res}(G)$  = The minimum  $k$  such that every  $k$ -subset is a resolving set.

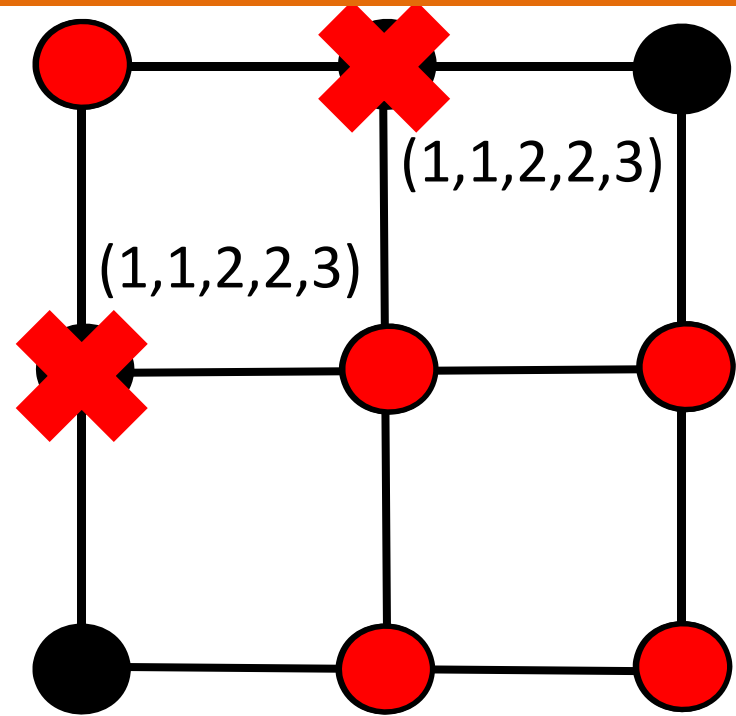

$$\text{res}(G) = 6$$

# Upper Dimension and Resolving Number

$\dim^+(G)$  = maximum size of a minimal resolving set

$\text{res}(G)$  = The minimum  $k$  such that every  $k$ -subset is a resolving set.

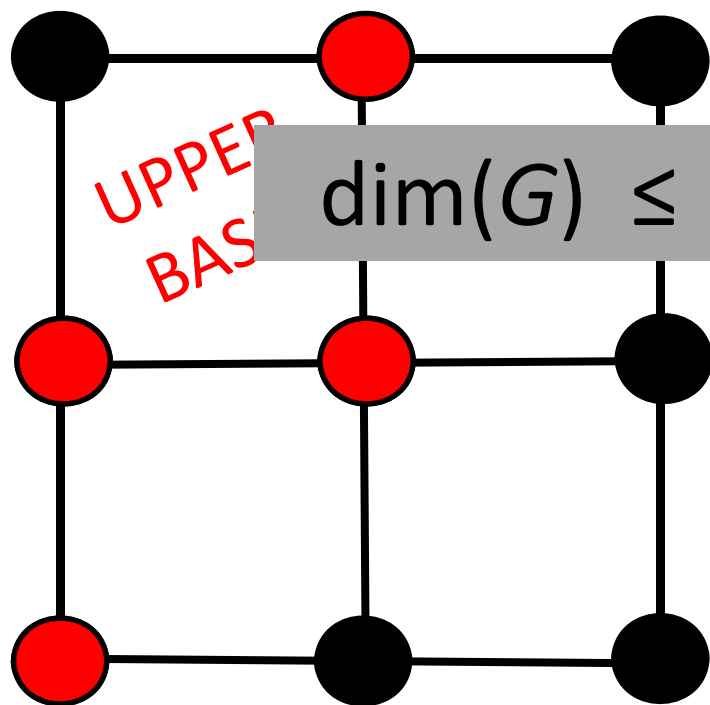

$$\dim^+(G) = 4$$

$$\dim(G) \leq \dim^+(G) \leq \text{res}(G)$$

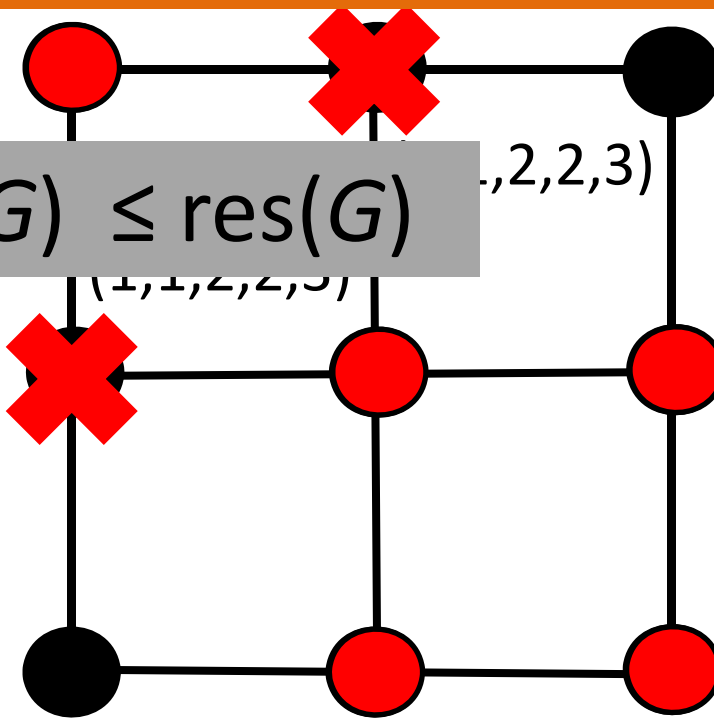

$$\text{res}(G) = 6$$

(1, 2, 2, 3)

(1, 1, 2, 2, 3)

$$\dim(G) \leq \dim^+(G) \leq \text{res}(G)$$

$$\dim(G) \leq \dim^+(G) \leq \text{res}(G)$$

# Realizability

$$\dim(G) \leq \dim^+(G) \leq \text{res}(G)$$

# Realizability

[Chartrand et al.,2000]

$$\dim(G) \leq \dim^+(G) \leq \text{res}(G)$$

# Realizability

[Chartrand et al.,2000]

$$\dim(G) \leq \dim^+(G) \leq \text{res}(G)$$

||  
a



# Realizability

[Chartrand et al., 2000]

$$\dim(G) \leq \dim^+(G) \leq \text{res}(G)$$

$\equiv$   
a

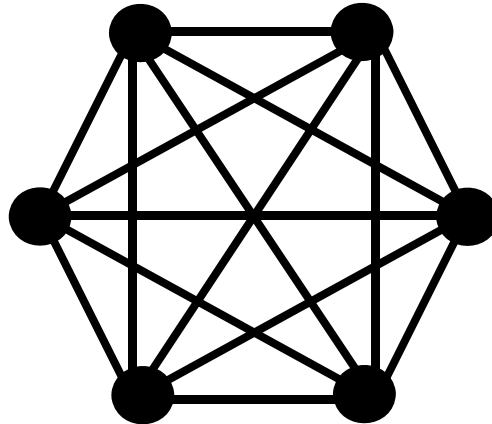

# Realizability

[Chartrand et al., 2000]

$$\dim(G) \leq \dim^+(G) \leq \text{res}(G)$$

$\parallel$   
a

$$\dim(K_n) = n - 1$$

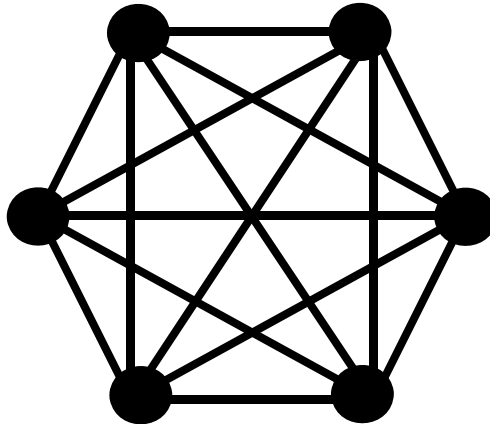

# Realizability

[Chartrand et al., 2000]

$$\dim(G) \leq \dim^+(G) \leq \text{res}(G)$$

$\equiv$   
C

$$\dim(K_n) = n - 1$$

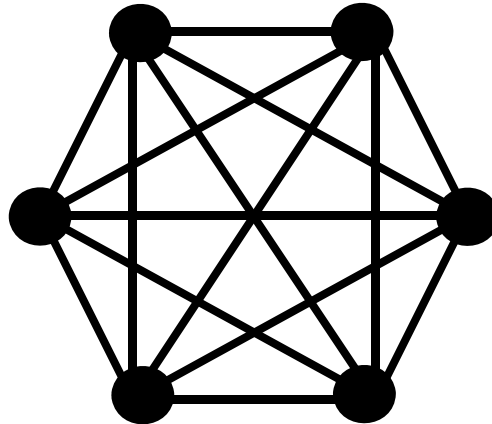

# Realizability

[Chartrand et al., 2000]

$$\dim(G) \leq \dim^+(G) \leq \text{res}(G)$$

$\parallel$   
C

$$\dim(K_n) = n - 1$$

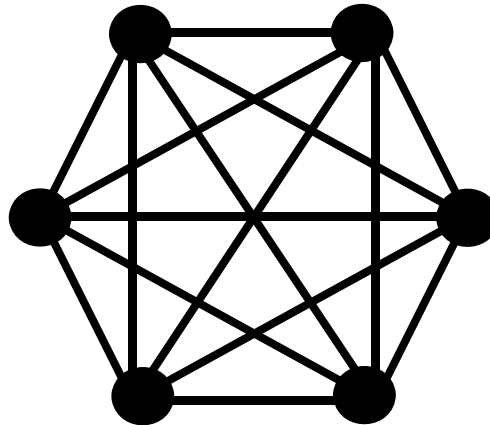

$$\text{res}(K_n) = n - 1$$

# Realizability

[Chartrand et al., 2000]

$$\dim(G) \leq \dim^+(G) \leq \text{res}(G)$$

||  
C

# Realizability

[Chartrand et al., 2000]

$$\dim(G) \leq \dim^+(G) \leq \text{res}(G)$$

||  
a

||  
c

# Realizability

[Chartrand et al., 2000]

$$\dim(G) \leq \dim^+(G) \leq \text{res}(G)$$

$\parallel$   
a

$\parallel$   
c

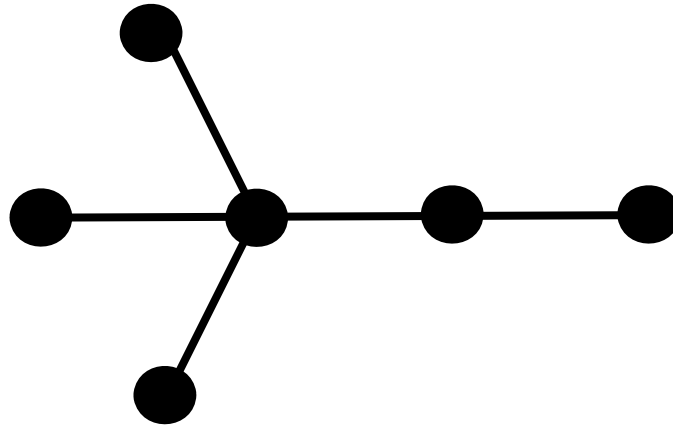

# Realizability

[Chartrand et al., 2000]

$$\dim(G) \leq \dim^+(G) \leq \text{res}(G)$$

$\parallel$   
a

$\parallel$   
c

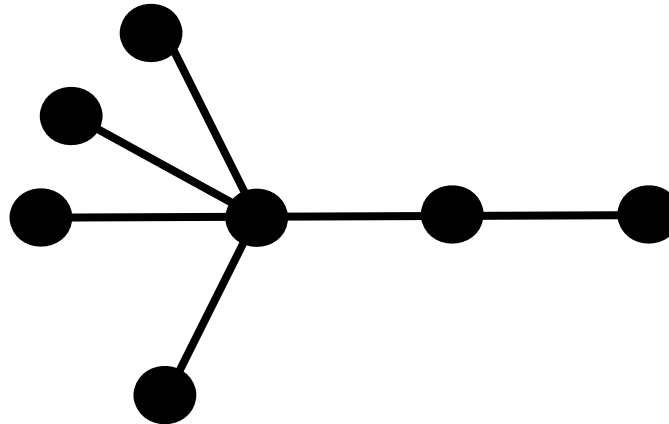



# Realizability

[Chartrand et al., 2000]

$$\dim(G) \leq \dim^+(G) \leq \text{res}(G)$$

$\parallel$   
a

$\parallel$   
c

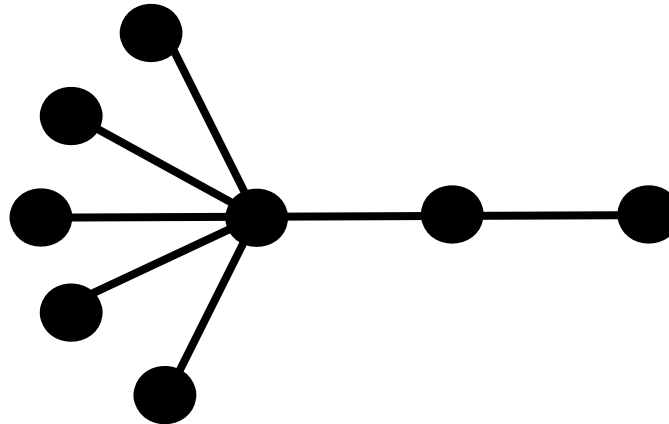

# Realizability

[Chartrand et al., 2000]

$$\dim(G) \leq \dim^+(G) \leq \text{res}(G)$$

$\parallel$   
a

$\parallel$   
c

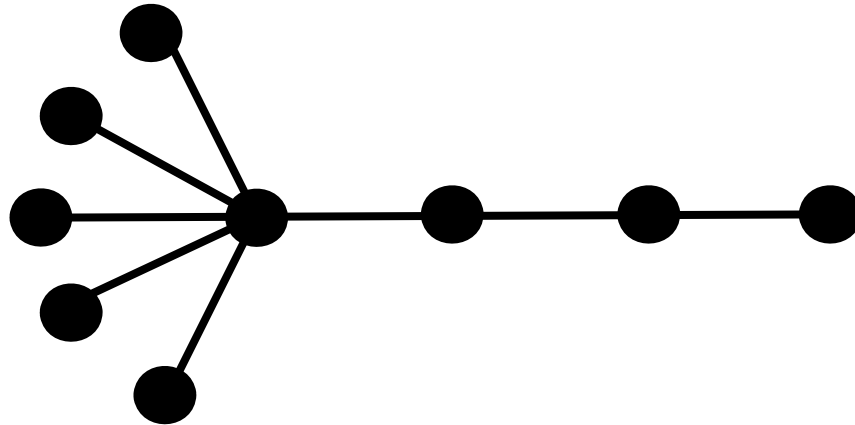

# Realizability

[Chartrand et al., 2000]

$$\dim(G) \leq \dim^+(G) \leq \text{res}(G)$$

$\parallel$   
a

$\parallel$   
c

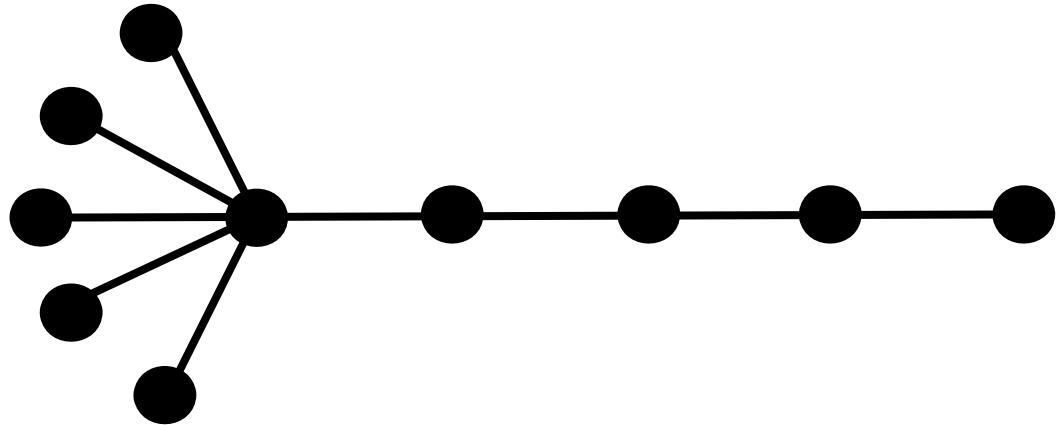

# Realizability

[Chartrand et al., 2000]

$$\dim(G) \leq \dim^+(G) \leq \text{res}(G)$$

$\parallel$   
a

$\parallel$   
c

# Realizability

[Chartrand et al., 2000]

$$\dim(G) \leq \dim^+(G) \leq \text{res}(G)$$

$\parallel$   
a

$\parallel$   
b

# Realizability

[Chartrand et al.,2000]

$$\dim(G) \leq \dim^+(G) \leq \text{res}(G)$$

$\parallel$   
 $a$

$\parallel$   
 $b$

Conjecture: For every pair  $a, b$  of integers with  $2 \leq a \leq b$ , there exists a connected graph  $G$  such that  $\dim(G)=a$  and  $\dim^+(G)=b$ .

Conjecture: For every pair  $a, b$  of integers with  $2 \leq a \leq b$ , there exists a connected graph  $G$  such that  $\dim(G) = a$  and  $\dim^+(G) = b$ .

Conjecture: For every pair  $a, b$  of integers with  $2 \leq a \leq b$ , there exists a connected graph  $G$  such that  $\dim(G) = a$  and  $\dim^+(G) = b$ .



Conjecture: For every pair  $a, b$  of integers with  $2 \leq a \leq b$ , there exists a connected graph  $G$  such that  $\dim(G) = a$  and  $\dim^+(G) = b$ .

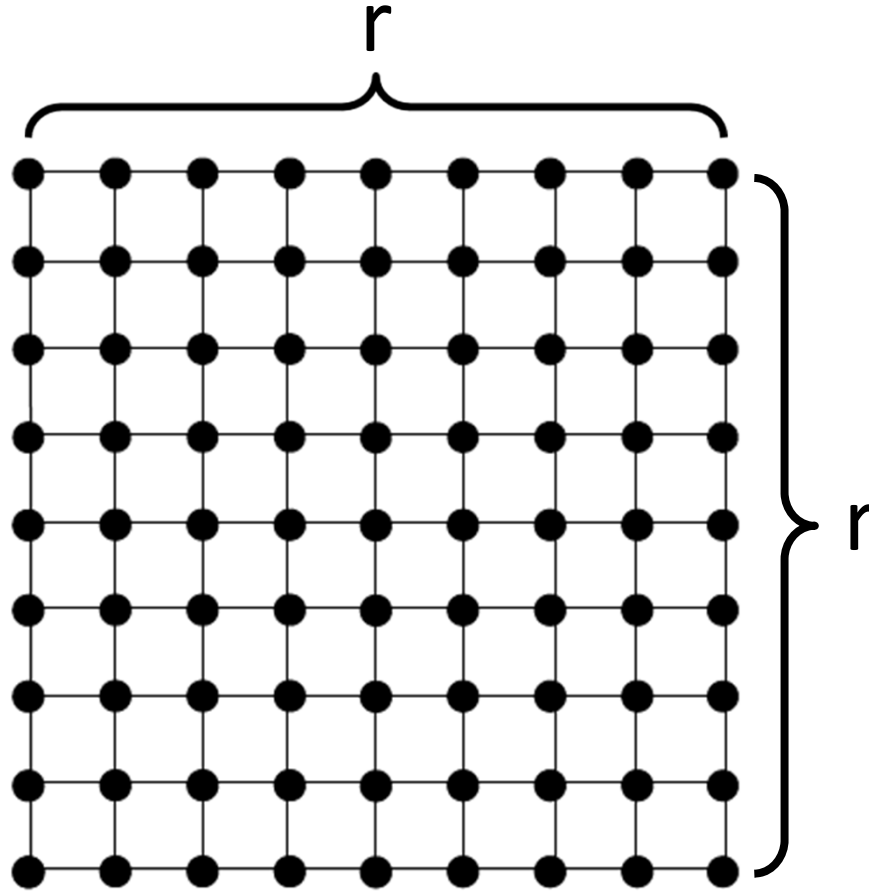

Conjecture: For every pair  $a, b$  of integers with  $2 \leq a \leq b$ , there exists a connected graph  $G$  such that  $\dim(G) = a$  and  $\dim^+(G) = b$ .

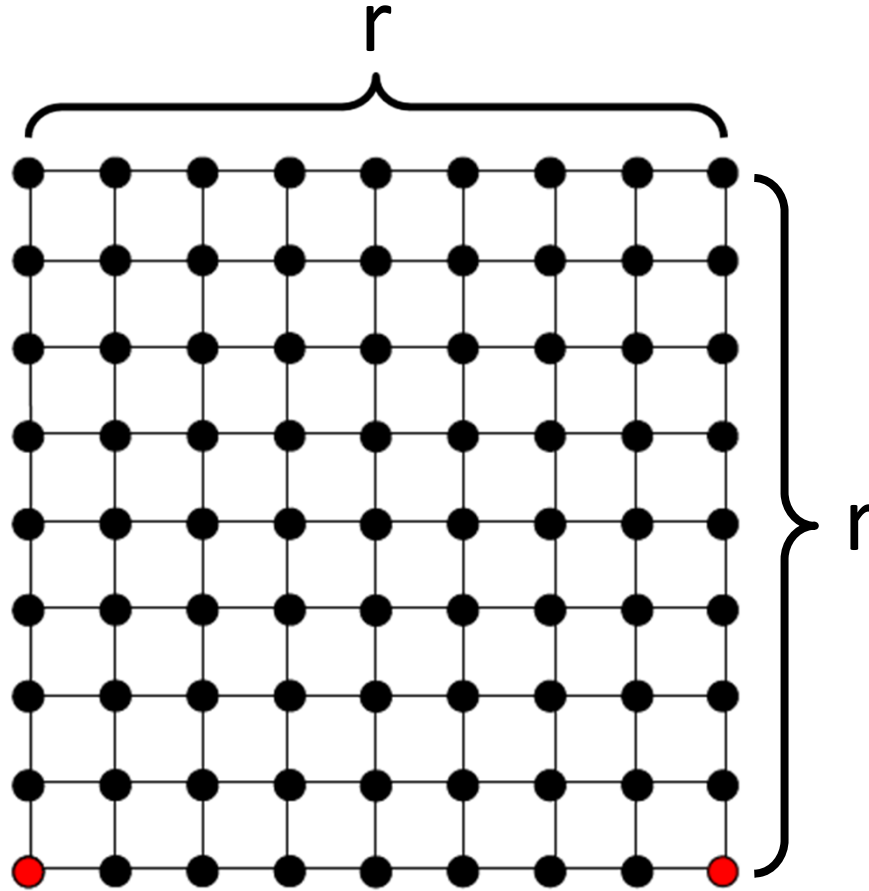

Conjecture: For every pair  $a, b$  of integers with  $2 \leq a \leq b$ , there exists a connected graph  $G$  such that  $\dim(G) = a$  and  $\dim^+(G) = b$ .

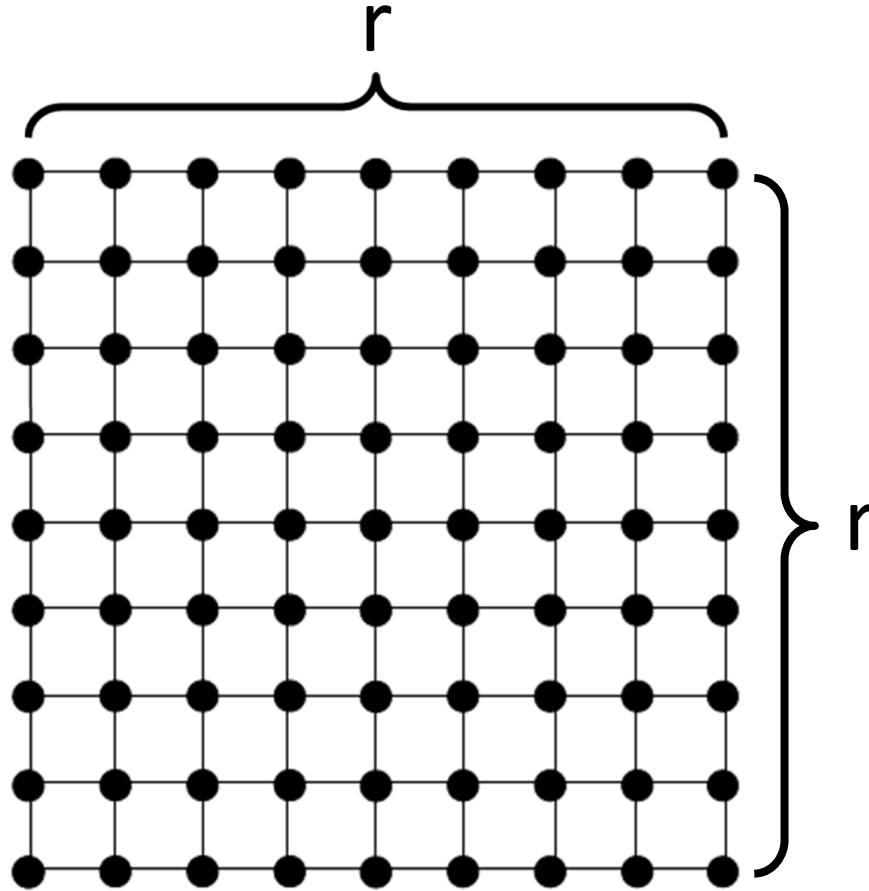

Conjecture: For every pair  $a, b$  of integers with  $2 \leq a \leq b$ , there exists a connected graph  $G$  such that  $\dim(G) = a$  and  $\dim^+(G) = b$ .

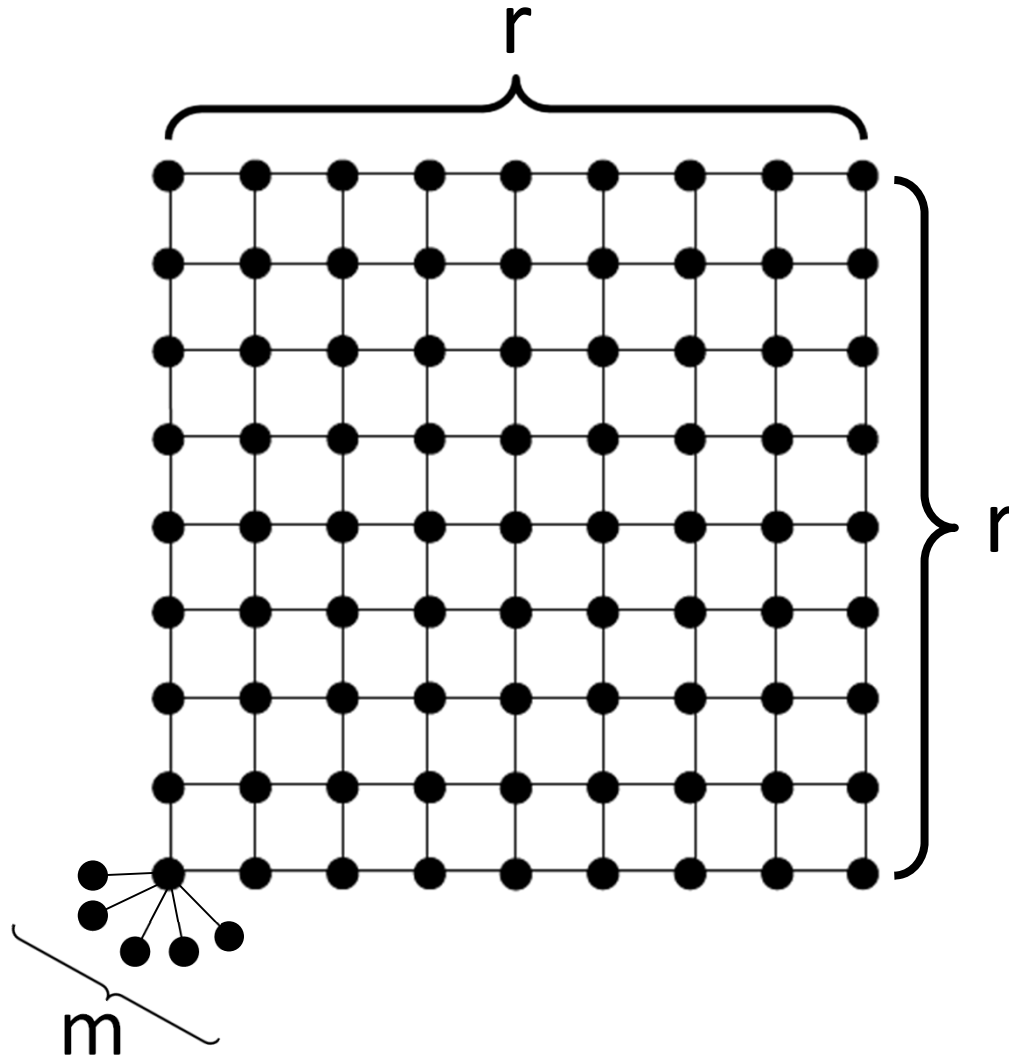

Conjecture: For every pair  $a, b$  of integers with  $2 \leq a \leq b$ , there exists a connected graph  $G$  such that  $\dim(G) = a$  and  $\dim^+(G) = b$ .

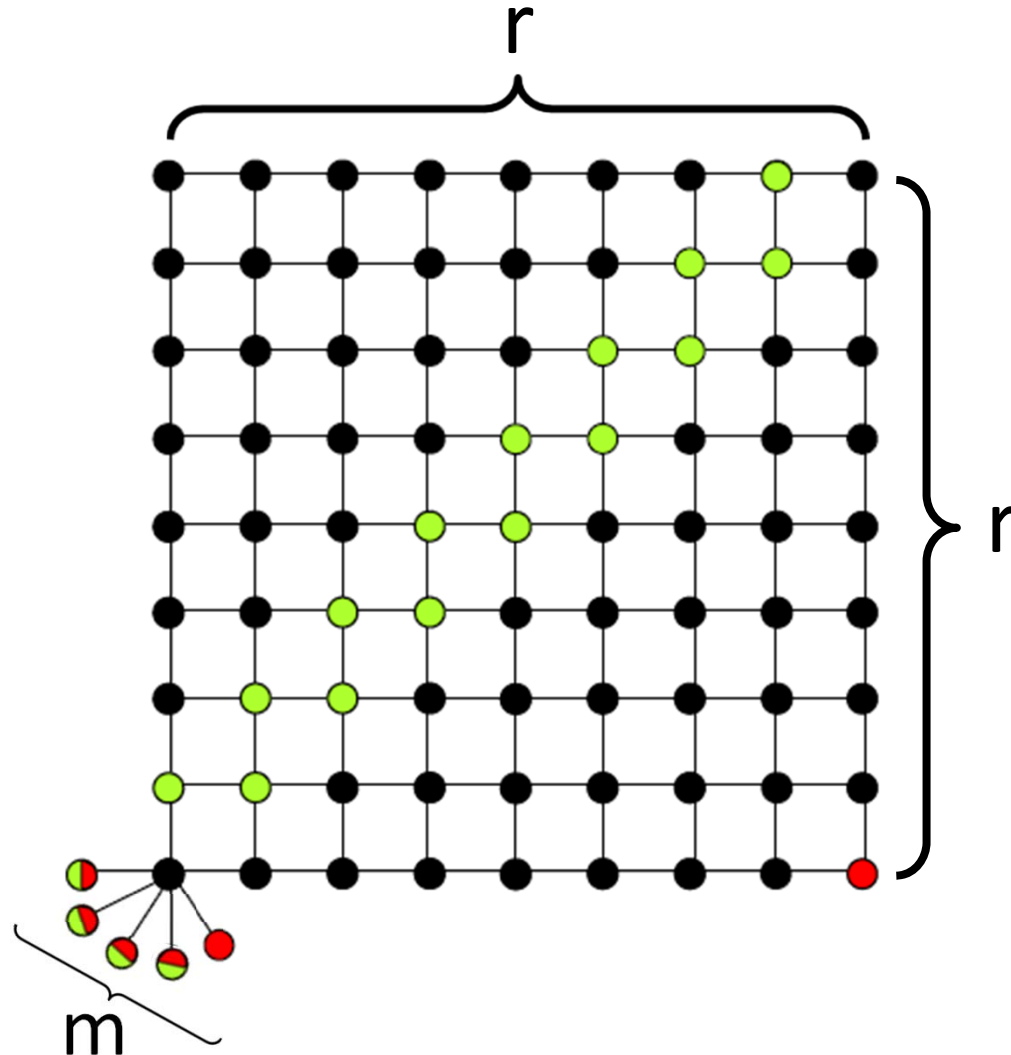

Theorem: For every pair  $a, b$  of integers with  $2 \leq a \leq b$ , there exists a connected graph  $G$  such that  $\dim(G) = a$  and  $\dim^+(G) = b$ .

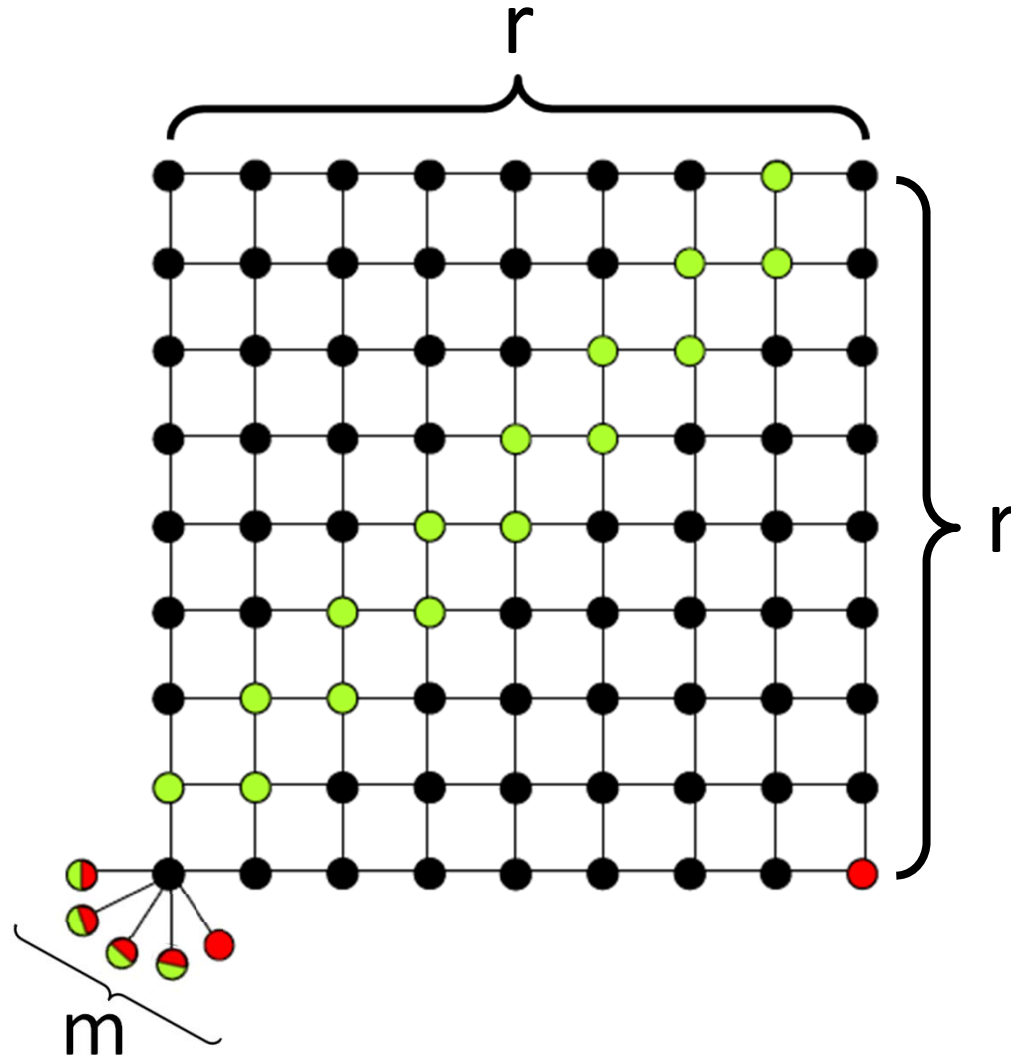

# Realizability

$$\dim(G) \leq \dim^+(G) \leq \text{res}(G)$$

# Realizability

$$\dim(G) \leq \dim^+(G) \leq \text{res}(G)$$

$\parallel$   
a

$\parallel$   
b



# Realizability

$$\dim(G) \leq \dim^+(G) \leq \text{res}(G)$$

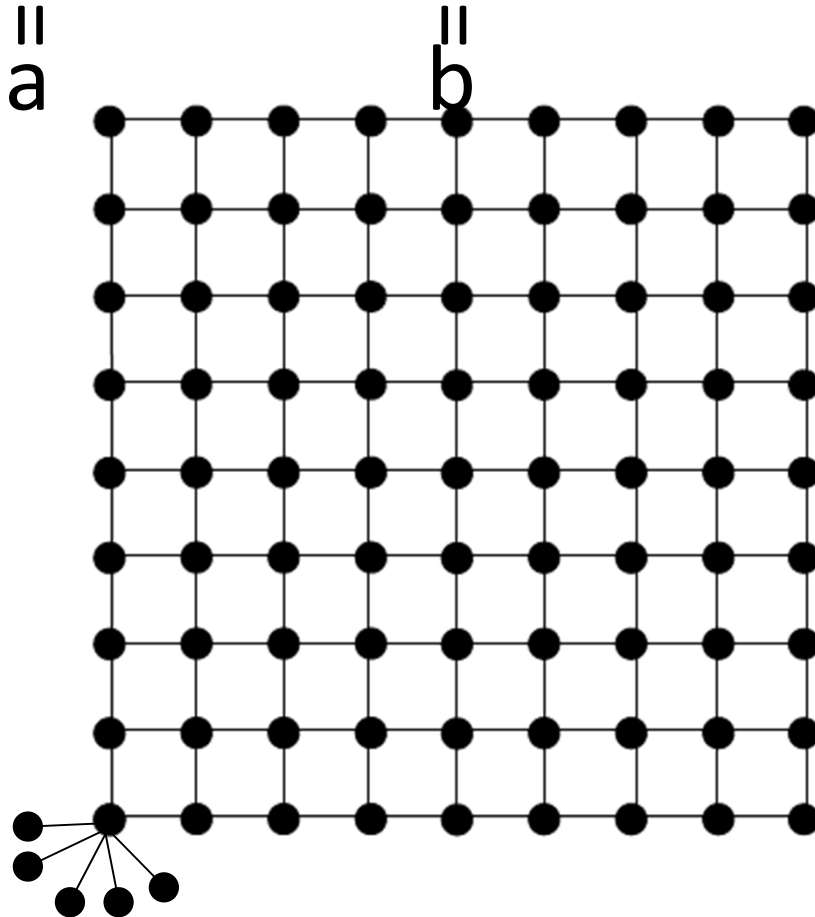

# Realizability

$$\dim(G) \leq \dim^+(G) \leq \text{res}(G)$$

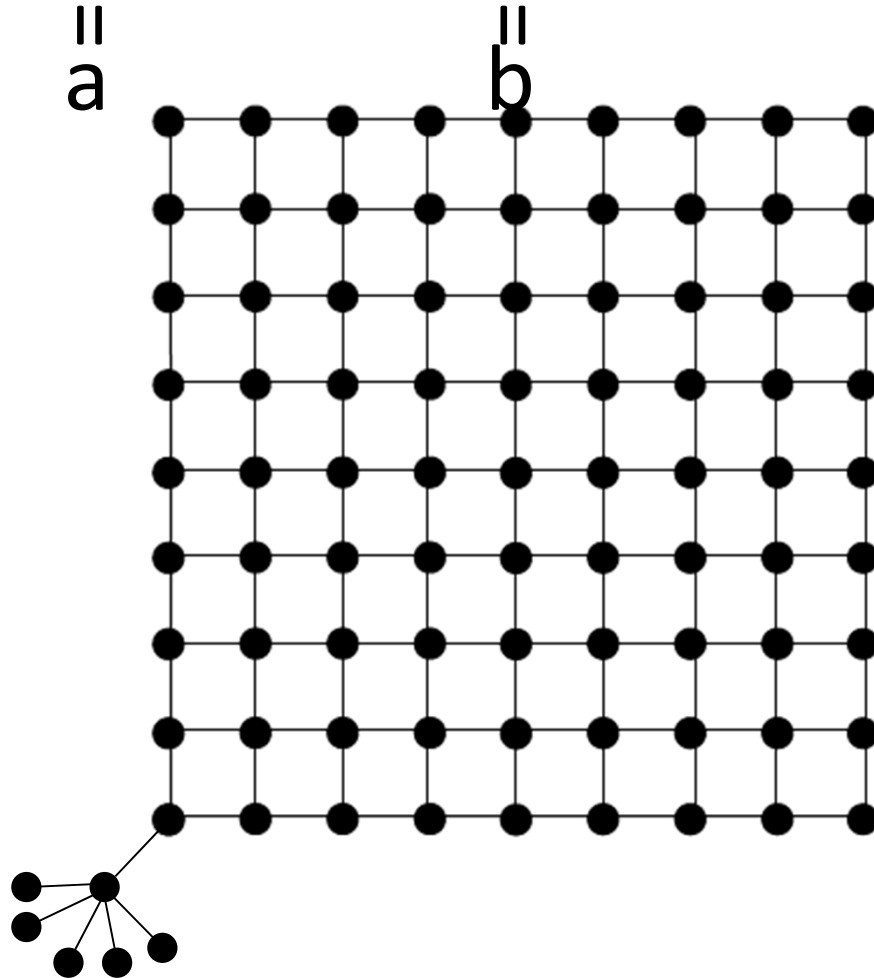

# Realizability

$$\dim(G) \leq \dim^+(G) \leq \text{res}(G)$$

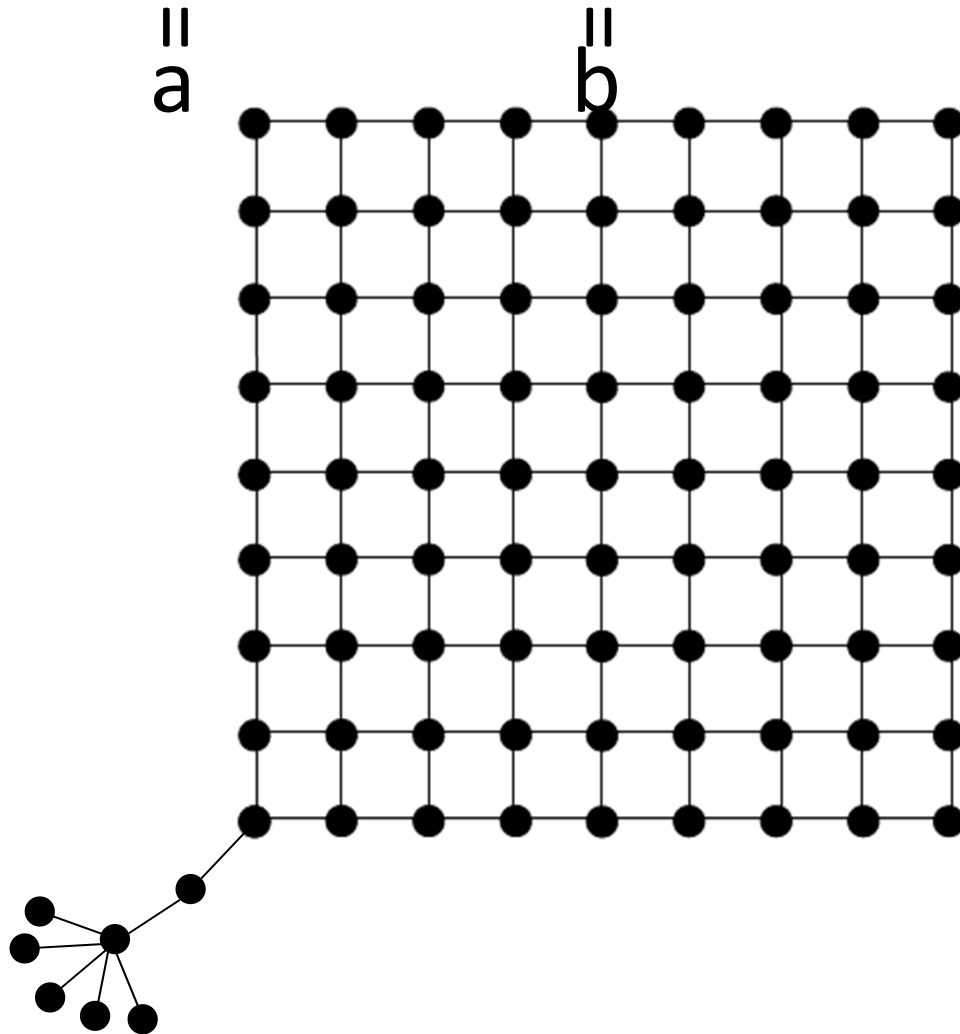

# Realizability

$$\dim(G) \leq \dim^+(G) \leq \text{res}(G)$$

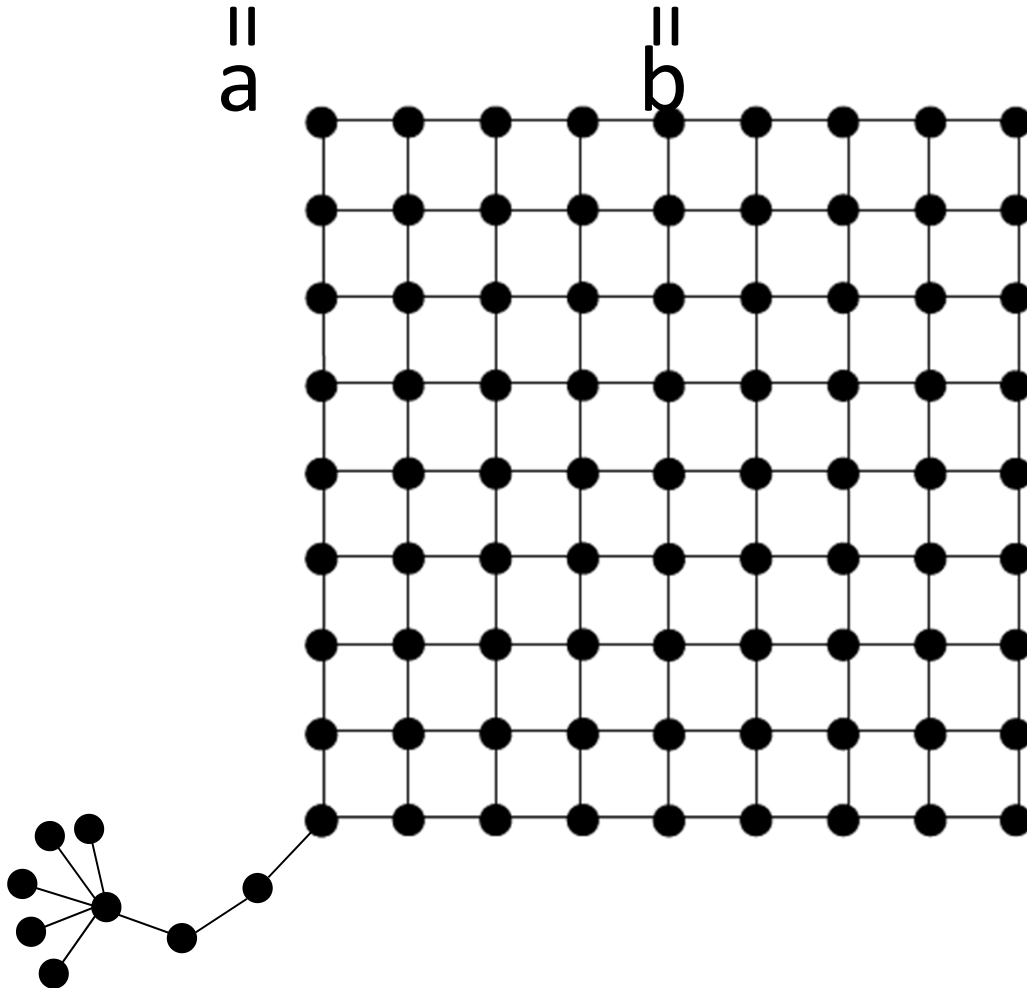

# Realizability

$$\dim(G) \leq \dim^+(G) \leq \text{res}(G)$$

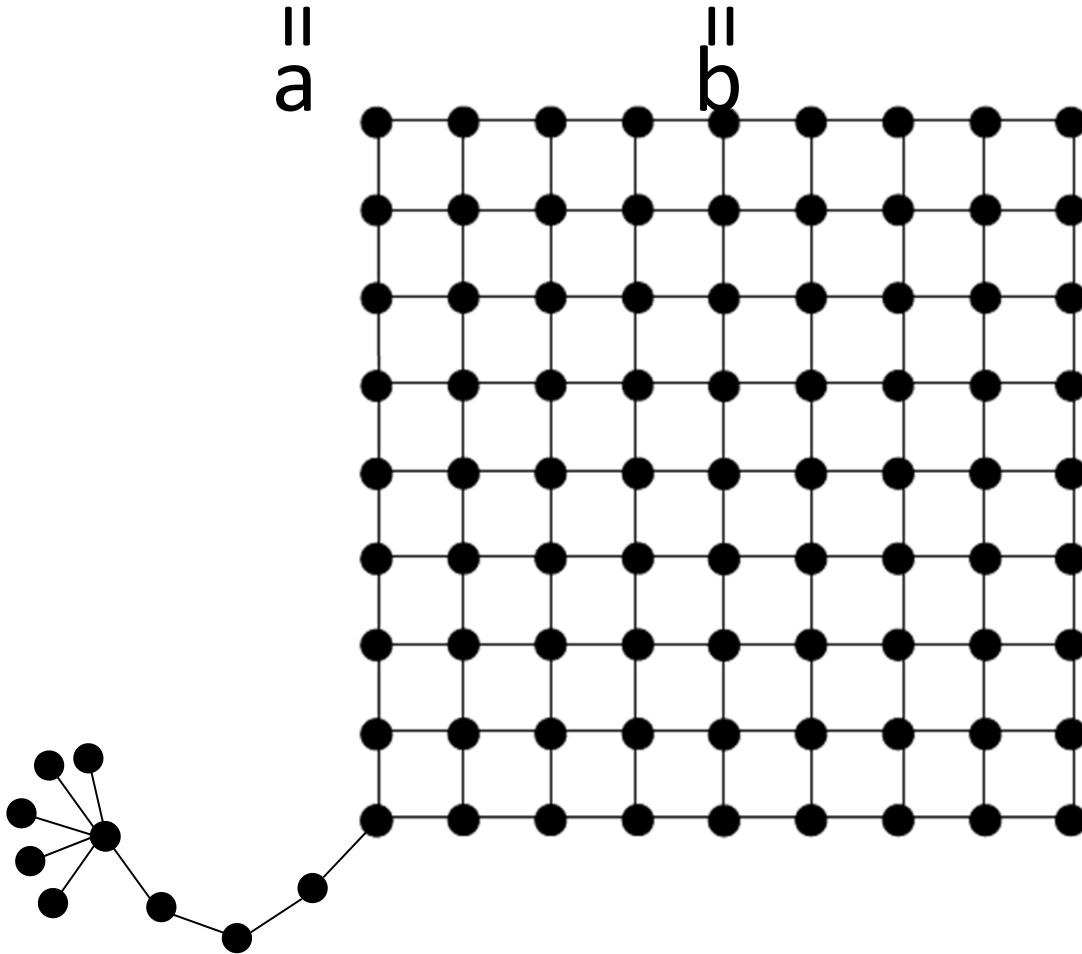

# Realizability

$$\dim(G) \leq \dim^+(G) \leq \text{res}(G)$$

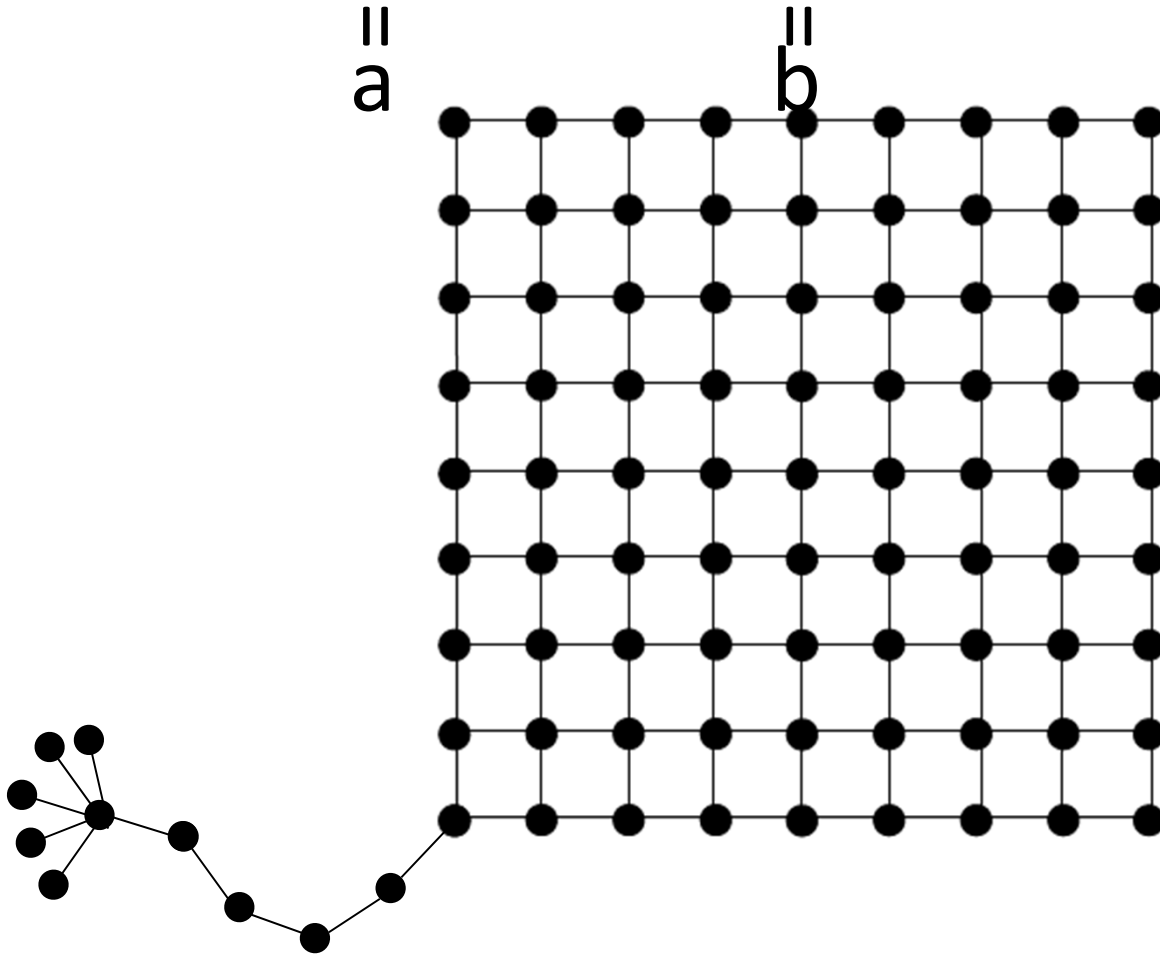

# Realizability

$$\dim(G) \leq \dim^+(G) \leq \text{res}(G)$$

$\parallel$   
a

$\parallel$   
b

# Realizability

$$\dim(G) \leq \dim^+(G) \leq \text{res}(G)$$

||  
C



# Realizability

$$\dim(G) \leq \dim^+(G) \leq \text{res}(G)$$

||  
C

[Garijo, G., Márquez]  $D \leq 3\text{res} - 5$  (res > 3)

# Realizability

$$\dim(G) \leq \dim^+(G) \leq \text{res}(G)$$

$\parallel$   
 $\mathbb{C}$

$$[\text{KhRaRo}'96] \quad n \leq D^{\dim} + \dim$$

$$[\text{Garijo,G.,Márquez}] \quad D \leq 3\text{res}-5 \quad (\text{res}>3)$$

# Realizability

$$\dim(G) \leq \dim^+(G) \leq \text{res}(G)$$

$\parallel$   
C

$$[\text{KhRaRo}'96] \quad n \leq D^{\dim} + \dim \leq$$

$$[\text{Garijo,G.,Márquez}] \quad D \leq 3\text{res}-5 \quad (\text{res}>3)$$

# Realizability

$$\dim(G) \leq \dim^+(G) \leq \text{res}(G)$$

$\equiv$   
C

$$[\text{KhRaRo}'96] \quad n \leq D^{\dim} + \dim \leq$$

$$[\text{Garijo,G.,Márquez}] \quad D \leq 3\text{res}-5 \quad (\text{res}>3)$$

# Realizability

$$\dim(G) \leq \dim^+(G) \leq \text{res}(G)$$

$\equiv$   
C

[KhRaRo'96]  $n \leq D^{\dim} + \dim \leq f(\text{res})$

[Garijo, G., Márquez]  $D \leq 3\text{res} - 5 \quad (\text{res} > 3)$

# Realizability

$$\dim(G) \leq \dim^+(G) \leq \text{res}(G)$$

$\parallel$   
C

[KhRaRo'96]  $n \leq D^{\dim} + \dim \leq f(\text{res})$

[Garijo,G.,Márquez]  $D \leq 3\text{res}-5 \quad (\text{res}>3)$

[Garijo,G.,Márquez] The set of graphs with resolving number  $a>3$  is finite.

# Realizability

$$\dim(G) \leq \dim^+(G) \leq \text{res}(G)$$

$\parallel$   
 $C$

[KhRaRo'96]  $n \leq D^{\dim} + \dim \leq f(\text{res})$

[Garijo,G.,Márquez]  $D \leq 3\text{res}-5 \quad (\text{res}>3)$

[Garijo,G.,Márquez] The set of graphs with resolving number  $a>3$  is finite.

QUESTION: Realization of triples  $(a,b,c)$ .

**THANKS!**